



LS 4071



Product Reference Guide



LS 4071 Product Reference Guide



70-19303-02
Revision A — December 1999

LS 4071 Product Reference Guide

70-19303-02

Revision A

December 1999



© 1999 by Symbol Technologies, Inc. All rights reserved.

No part of this publication may be reproduced or used in any form, or by any electrical or mechanical means, without permission in writing from Symbol. This includes electronic or mechanical means, such as photocopying, recording, or information storage and retrieval systems. The material in this manual is subject to change without notice.

The software is provided strictly on an "as is" basis. All software, including firmware, furnished to the user is on a licensed basis. Symbol grants to the user a non-transferable and non-exclusive license to use each software or firmware program delivered hereunder (licensed program). Except as noted below, such license may not be assigned, sublicensed, or otherwise transferred by the user without prior written consent of Symbol. No right to copy a licensed program in whole or in part is granted, except as permitted under copyright law. The user shall not modify, merge, or incorporate any form or portion of a licensed program with other program material, create a derivative work from a licensed program, or use a licensed program in a network without written permission from Symbol. The user agrees to maintain Symbol's copyright notice on the licensed programs delivered hereunder, and to include the same on any authorized copies it makes, in whole or in part. The user agrees not to decompile, disassemble, decode, or reverse engineer any licensed program delivered to the user or any portion thereof.

Symbol reserves the right to make changes to any software or product to improve reliability, function, or design.

Symbol does not assume any product liability arising out of, or in connection with, the application or use of any product, circuit, or application described herein.

No license is granted, either expressly or by implication, estoppel, or otherwise under any Symbol Technologies, Inc., intellectual property rights. An implied license only exists for equipment, circuits, and subsystems contained in Symbol products.

Symbol, Spectrum One, and Spectrum24 are registered trademarks of Symbol Technologies, Inc. Other product names mentioned in this manual may be trademarks or registered trademarks of their respective companies and are hereby acknowledged.

Symbol Technologies, Inc.
One Symbol Plaza
Holtsville, New York 11742-1300
<http://www.symbol.com>

Patents

This product is covered by one or more of the following U.S. and foreign Patents:

U.S. Patent No.4,360,798; 4,369,361; 4,387,297; 4,460,120; 4,496,831; 4,593,186; 4,603,262; 4,607,156; 4,652,750; 4,673,805; 4,736,095; 4,758,717; 4,816,660; 4,845,350; 4,896,026; 4,897,532; 4,923,281; 4,933,538; 4,992,717; 5,015,833; 5,017,765; 5,021,641; 5,029,183; 5,047,617; 5,103,461; 5,113,445; 5,130,520; 5,140,144; 5,142,550; 5,149,950; 5,157,687; 5,168,148; 5,168,149; 5,180,904; 5,216,232; 5,229,591; 5,230,088; 5,235,167; 5,243,655; 5,247,162; 5,250,791; 5,250,792; 5,260,553; 5,262,627; 5,262,628; 5,266,787; 5,278,398; 5,280,162; 5,280,163; 5,280,164; 5,280,498; 5,304,786; 5,304,788; 5,306,900; 5,321,246; 5,324,924; 5,337,361; 5,367,151; 5,373,148; 5,378,882; 5,396,053; 5,396,055; 5,399,846; 5,408,081; 5,410,139; 5,410,140; 5,412,198; 5,418,812; 5,420,411; 5,436,440; 5,444,231; 5,449,891; 5,449,893; 5,468,949; 5,471,042; 5,478,998; 5,479,000; 5,479,002; 5,479,441; 5,504,322; 5,519,577; 5,528,621; 5,532,469; 5,543,610; 5,545,889; 5,552,592; 5,557,093; 5,578,810; 5,581,070; 5,589,679; 5,589,680; 5,608,202; 5,612,531; 5,619,028; 5,627,359; 5,637,852; 5,664,229; 5,668,803; 5,675,139; 5,693,929; 5,698,835; 5,705,800; 5,714,746; 5,723,851; 5,734,152; 5,734,153; 5,742,043; 5,745,794; 5,754,587; 5,762,516; 5,763,863; 5,767,500; 5,789,728; 5,789,731; 5,808,287; 5,811,785; 5,811,787; 5,815,811; 5,821,519; 5,821,520; 5,823,812; 5,828,050; 5,850,078; 5,861,615; 5,874,720; 5,875,415; 5,900,617; 5,902,989; 5,907,146; 5,912,450; 5,914,478; 5,917,173; 5,920,059; 5,923,025; 5,929,420; 5,945,658; 5,945,659; 5,946,194; 5,959,285; D305,885; D341,584; D344,501; D359,483; D362,453; D363,700; D363,918; D370,478; D383,124; D391,250; D405,077; D406,581; D414,171; D414,172.

Invention No. 55,358; 62,539; 69,060; 69,187 (Taiwan); No. 1,601,796; 1,907,875; 1,955,269 (Japan).

European Patent 367,299; 414,281; 367,300; 367,298; UK 2,072,832; France 81/03938; Italy 1,138,713.

rev. 11/99

Contents

About This Manual

Notational Conventions	vii
Related Publications	vii
Symbol Support Centers	viii
Warranty Coverage and Procedurexi
Generalxi

Chapter 1. The LS 4071 Scanner

Scanning Made Easy	1-1
Rechargeable Battery Pack	1-2
The Base Station	1-3

Chapter 2. Set Up

Unpacking	2-1
Setting Up the Base Station	2-1
Charging the Battery	2-3
Battery Life	2-4
Pairing the Scanner with the Base Station	2-4
Connecting to a Host	2-5
RS-232C	2-5
IBM 468X/9X	2-5
Wand Emulation, OCIA, OCR, Keyboard Wedges	2-7

Chapter 3. Scanning

Ready, Test, Scan	3-1
Aiming	3-2
Scan the Entire Symbol	3-2
Hold at an Angle	3-3
LS 4071 Decode Zone	3-4
What If...	3-5
Programming the System	3-6

Chapter 4. Maintenance and Specifications

Maintenance	4-1
Changing Battery Packs	4-2
To Change a Battery Pack:	4-3
Charge Status LED Indications	4-6
Accessories	4-7

Required Accessories	4-7
Optional Accessories	4-7
Technical Specifications	4-8
Base Pin Outs	4-10
Beeper Indications	4-11

Chapter 5. Parameter Menus

Set Default Parameter	5-7
Host Type	5-8
IBM 46XX Host Types	5-8
RS-232C Host Types	5-9
Beeper Tone	5-12
Beeper Volume	5-13
Laser On Time	5-14
Base Beep After Good Decode	5-15
Scanner Beep After Good Decode	5-16
Base Beep Type	5-17
Transmit "No Read" Message	5-18
Linear Code Type Security Level	5-19
Bi-directional Redundancy	5-22
Enable/Disable UPC-E/UPC-A	5-23
Enable/Disable EAN-8/EAN-13	5-24
Enable/Disable Bookland EAN	5-25
Decode UPC/EAN Supplementals	5-26
Decode UPC/EAN Supplemental Redundancy	5-27
Transmit UPC-A/UPC-E Check Digit	5-28
UPC-A Preamble	5-29
UPC-E Preamble	5-30
Convert UPC-E to UPC-A	5-31
EAN Zero Extend	5-32
Convert EAN-8 to EAN-13 Type	5-33
UPC/EAN Security Level	5-34
UPC/EAN Coupon Code	5-36
Enable/Disable Code 128	5-37
Enable/Disable UCC/EAN-128	5-38
Lengths for Code 128	5-39
Enable/Disable Code 39	5-40
Enable/Disable Trioptic Code 39	5-41
Set Lengths for Code 39	5-42
Code 39 Check Digit Verification	5-44
Transmit Code 39 Check Digit	5-45
Enable/Disable Code 39 Full ASCII	5-46
Code 39 Buffering (Scan & Store)	5-47

Buffer Data	5-48
Clear Transmission Buffer	5-48
Transmit Buffer	5-49
Overfilling Transmission Buffer	5-49
Attempt to Transmit an Empty Buffer	5-49
Convert Code 39 to Code 32.....	5-50
Enable/Disable Code 93	5-51
Set Lengths for Code 93	5-52
Enable/Disable Interleaved 2 of 5	5-54
Set Lengths for Interleaved 2 of 5	5-55
I 2 of 5 Check Digit Verification.....	5-57
Transmit I 2 of 5 Check Digit	5-58
Convert I 2 of 5 to EAN-13	5-59
Enable/Disable Discrete 2 of 5	5-60
Set Lengths for Discrete 2 of 5	5-61
Enable/Disable Codabar	5-63
Set Lengths for Codabar	5-64
CLSI Editing	5-66
NOTIS Editing	5-67
Enable/Disable MSI Plessey	5-68
Set Lengths for MSI Plessey	5-69
MSI Plessey Check Digits	5-71
Transmit MSI Plessey Check Digit	5-72
MSI Plessey Check Digit Algorithm	5-73
Transmit Code ID Character	5-74
Pause Duration.....	5-76
Prefix/Suffix Values	5-77
Scan Data Transmission Format	5-78
Transmit ASCII/Intermediate Data	5-80
RS-232C Parameters.....	5-81
Baud Rate	5-81
Parity	5-83
Check Receive Errors.....	5-85
Hardware Handshaking.....	5-86
RS-232C Parameters.....	5-87
Software Handshaking	5-89
Host Serial Response Time-out	5-92
RTS Line State.....	5-93
Stop Bit Select	5-94
ASCII Format	5-95
Beep on <BEL>.....	5-96
Intercharacter Delay	5-97
Numeric Bar Codes	5-98
Cancel	5-100

Appendix A.

UCC/EAN-128..... A-2
AIM Code Identifiers..... A-4

Appendix B. Glossary

Index

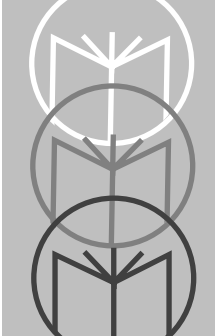

About This Manual

The *LS 4071 Product Reference Guide* provides general instructions for setup, operation, troubleshooting, maintenance, and programming.

Notational Conventions

The following conventions are used in this document:

- Bullets (•) indicate:
 - action items
 - lists of alternatives
 - lists of required steps that are not necessarily sequential
- Sequential lists (e.g., those that describe step-by-step procedures) appear as numbered lists.

Related Publications

- *LS 4071 Quick Reference Guide* p/n 70-19478-01

Service Information

If you have a problem with your equipment, contact the *Symbol Support Centers*. Before calling, have the model number, serial number, and several of your bar code symbols at hand.

Call the Support Center from a phone near the scanning equipment so that the service person can try to talk you through your problem. If the equipment is found to be working properly and the problem is symbol readability, the Support Center will request samples of your bar codes for analysis at our plant.

If your problem cannot be solved over the phone, you may need to return your equipment for servicing. If that is necessary, you will be given specific directions.



Note: *Symbol Technologies is not responsible for any damages incurred during shipment if the approved shipping container is not used. Shipping the units improperly can possibly void the warranty. If the original shipping container was not kept, contact Symbol to have another sent to you.*

Symbol Support Centers

For service information, warranty information or technical assistance contact or call the Symbol Support Center in:

United States

Symbol Technologies, Inc.
One Symbol Plaza
Holtsville, New York 11742-1300
1-800-653-5350

United Kingdom

Symbol Technologies
Symbol Place
Winnersh Triangle, Berkshire RG41 5TP
United Kingdom
0800 328 2424 (Inside UK)
+44 118 945 7529 (Outside UK)

Australia

Symbol Technologies Pty. Ltd.
432 St. Kilda Road
Melbourne, Victoria 3004
1-800-672-906 (Inside Australia)
+61-3-9866-6044 (Outside Australia)

Denmark

Symbol Technologies AS
Gydevang 2,
DK-3450 Allerød, Denmark
7020-1718 (Inside Denmark)
+45-7020-1718 (Outside Denmark)

Canada

Symbol Technologies Canada, Inc.
2540 Matheson Boulevard East
Mississauga, Ontario, Canada L4W 4Z2
905-629-7226

Asia/Pacific

Symbol Technologies Asia, Inc.
230 Victoria Street #04-05
Bugis Junction Office Tower
Singapore 188024
337-6588 (Inside Singapore)
+65-337-6588 (Outside Singapore)

Austria

Symbol Technologies Austria GmbH
Prinz-Eugen Strasse 70
Suite 3
2.Haus, 5.Stock
1040 Vienna, Austria
1-505-5794 (Inside Austria)
+43-1-505-5794 (Outside Austria)

Europe/Mid-East Distributor Operations

Contact your local distributor or call
+44 118 945 7360

Finland

Oy Symbol Technologies
Kaupintie 8 A 6
FIN-00440 Helsinki, Finland
9 5407 580 (Inside Finland)
+358 9 5407 580 (Outside Finland)

Germany

Symbol Technologies GmbH
Waldstrasse 68
D-63128 Dietzenbach, Germany
6074-49020 (Inside Germany)
+49-6074-49020 (Outside Germany)

Latin America Sales Support

7900 Glades Road
Suite 340
Boca Raton, Florida 33434 USA
1-800-347-0178 (Inside United States)
+1-561-483-1275 (Outside United States)

Netherlands

Symbol Technologies
Kerkplein 2, 7051 CX
Postbus 24 7050 AA
Varsseveld, Netherlands
315-271700 (Inside Netherlands)
+31-315-271700 (Outside Netherlands)

France

Symbol Technologies France
Centre d'Affaire d'Antony
3 Rue de la Renaissance
92184 Antony Cedex, France
01-40-96-52-21 (Inside France)
+33-1-40-96-52-50 (Outside France)

Italy

Symbol Technologies Italia S.R.L.
Via Cristoforo Colombo, 49
20090 Trezzano S/N Navigilo
Milano, Italy
2-484441 (Inside Italy)
+39-02-484441 (Outside Italy)

Mexico

Symbol Technologies Mexico Ltd.
Torre Picasso
Boulevard Manuel Avila Camacho No 88
Lomas de Chapultepec CP 11000
Mexico City, DF, Mexico
5-520-1835 (Inside Mexico)
+52-5-520-1835 (Outside Mexico)

Norway

Symbol Technologies
Trollasveien 36
Postboks 72
1414 Trollasen, Norway
66810600 (Inside Norway)
+47-66810600 (Outside Norway)



South Africa

Symbol Technologies Africa Inc.
Block B2
Rutherford Estate
1 Scott Street
Waverly 2090 Johannesburg
Republic of South Africa
11-4405668 (Inside South Africa)
+27-11-4405668 (Outside South Africa)

Spain

Symbol Technologies S.A.
Edificio la Piovera Azul
C. Peonias, No. 2 - Sexta Planta
28042 Madrid, Spain
9-1-320-39-09 (Inside Spain)
+34-9-1-320-39-09 (Outside Spain)

Sweden

Symbol Technologies AB
Albygatan 109D
Solna
Sweden
84452900 (Inside Sweden)
+46 84452900 (Outside Sweden)

If you purchased your Symbol product from a Symbol Business Partner, contact that Business Partner for service.

Warranty

Symbol Technologies, Inc ("Symbol") manufactures its hardware products in accordance with industry-standard practices. Symbol warrants that for a period of twelve (12) months from date of shipment, products will be free from defects in materials and workmanship.

This warranty is provided to the original owner only and is not transferable to any third party. It shall not apply to any product (i) which has been repaired or altered unless done or approved by Symbol, (ii) which has not been maintained in accordance with any operating or handling instructions supplied by Symbol, (iii) which has been subjected to unusual physical or electrical stress, misuse, abuse, power shortage, negligence or accident or (iv) which has been used other than in accordance with the product operating and handling instructions. Preventive maintenance is the responsibility of customer and is not covered under this warranty.

Wear items and accessories having a Symbol serial number, will carry a 90-day limited warranty. Non-serialized items will carry a 30-day limited warranty.

Warranty Coverage and Procedure

During the warranty period, Symbol will repair or replace defective products returned to Symbol's manufacturing plant in the US. For warranty service in North America, call the Symbol Support Center at 1-800-653-5350. International customers should contact the local Symbol office or support center. If warranty service is required, Symbol will issue a Return Material Authorization Number. Products must be shipped in the original or comparable packaging, shipping and insurance charges prepaid. Symbol will ship the repaired or replacement product freight and insurance prepaid in North America. Shipments from the US or other locations will be made F.O.B. Symbol's manufacturing plant.

Symbol will use new or refurbished parts at its discretion and will own all parts removed from repaired products. Customer will pay for the replacement product in case it does not return the replaced product to Symbol within 3 days of receipt of the replacement product. The process for return and customer's charges will be in accordance with Symbol's Exchange Policy in effect at the time of the exchange.

Customer accepts full responsibility for its software and data including the appropriate backup thereof.

Repair or replacement of a product during warranty will not extend the original warranty term.

Symbol's Customer Service organization offers an array of service plans, such as on-site, depot, or phone support, that can be implemented to meet customer's special operational requirements and are available at a substantial discount during warranty period.

General

Except for the warranties stated above, Symbol disclaims all warranties, express or implied, on products furnished hereunder, including without limitation implied warranties of merchantability and fitness for a particular purpose. The stated express warranties are in lieu of all obligations or liabilities on part of Symbol for damages, including without limitation, special, indirect, or consequential damages arising out of or in connection with the use or performance of the product.

Seller's liability for damages to buyer or others resulting from the use of any product, shall in no way exceed the purchase price of said product, except in instances of injury to persons or property.

Some states (or jurisdictions) do not allow the exclusion or limitation of incidental or consequential damages, so the proceeding exclusion or limitation may not apply to you.



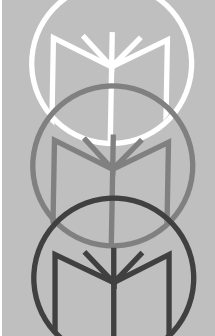

Chapter 1 The LS 4071 Scanner

Scanning Made Easy

The LS 4071 scanner lets you scan a bar code and transmit the data to a base station up to 10 feet (3 meters) away, without a physical cable to limit your movement. Instead, the scanner communicates with the base station through a low power radio transmission.

The base station also serves as a charging station for the scanner's battery pack.

There are two systems from which to choose.

- LS 4074 - An LS 4071 scanner and an RL474 base station. This system allows you to communicate with an RS-232 host with a direct connect cable, or to most other terminal types by using a Symbol Synapse™ Smart Cable.
- LS 4075 - An LS 4071 scanner and an RL475 base station. This system is compatible with the entire line of IBM 468X/469X terminals. Like the RL474, this base station also accommodates the full line of Synapse Smart Cables.

Additionally, there are different laser classes and transmission frequencies for various global locations. Ask your Symbol representative for specific information.

The LS 4071 successfully reads most code symbologies, densities, and colors, produced by a wide range of printing techniques, and scans at the rate of 36 scans per second. See the **LS 4071 Decode Zone** on page 3-4.



Rechargeable Battery Pack

In the handle of the scanner, there is a rechargeable NiCad battery pack. This provides all power to the scanner during normal operation. It provides 250 mA hours, which is sufficient for normal operation during a typical 12-hour shift.

When fully depleted, the battery pack can be recharged to full charge within 2 hours, with the LS 4071 inserted into the RL 47X base station. Alternatively, the battery module can be recharged in the Universal Four-Slot Charger/Recharger in approximately 1 1/2 hours.

The Base Station

The base station receives scan data from the scanner via an RF transmission and acknowledges receipt with an audible beep. It then transmits that data to the host device through an attached cable. It also acts as a holder for the scanner.

The base station serves as a charging stand capable of charging the scanner's battery pack (in the handle). The charging stand has a charge status indicator light.

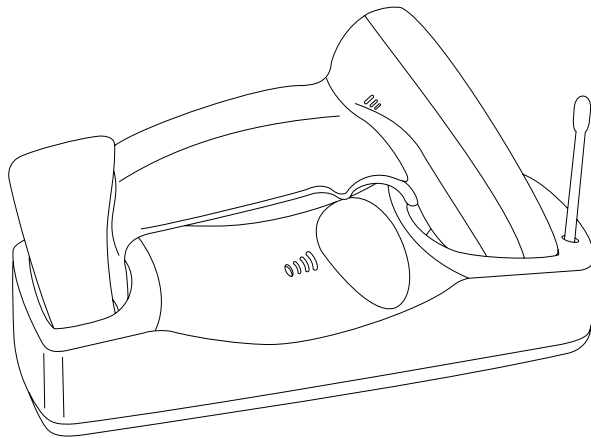
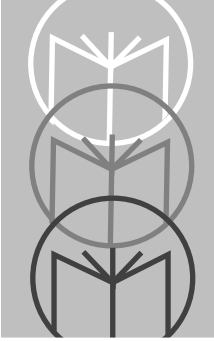

Figure 1-1. Scanner and Base Station





Chapter 2 Set Up

Unpacking

Remove the scanner from its packing and inspect it for damage. If the scanner was damaged in transit, call the **Symbol Support Center** at one of the telephone numbers listed on page viii. **KEEP THE PACKING.** It is the approved shipping container and should be used if you ever need to return your equipment for servicing.

Setting Up the Base Station

1. Place the base station on a horizontal surface. Remember the scanner's operating range is approximately 10 feet (3 meters). It is preferable to have the scanner and base station in line of sight. Placing the base station near any large metal mass (e.g., a filing cabinet) may interfere with scanner/base station communications. The base station may be placed on a shelf below a counter. This placement, however, may also result in less than optimum scanner/base station communications.
2. Connect an interface or adapter cable (for Synapse cables) to the base station.
3. If using a direct connect interface cable, it should be connected to the appropriate connector on the host. See **Connecting to a Host** on page 2-5.

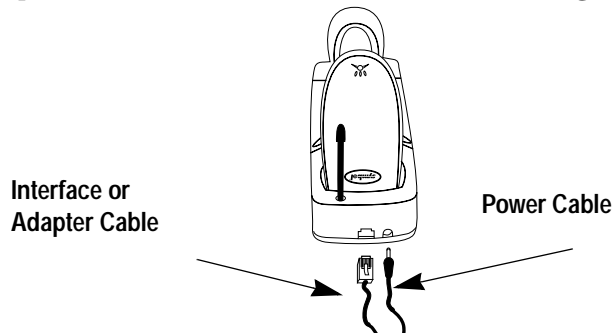

Figure 2-1. Host and Power Cables



4. The Synapse adapter cables have a flying power lead. Connect this lead to the receptacle in the Synapse cable, as shown below. See the Synapse guide for details.

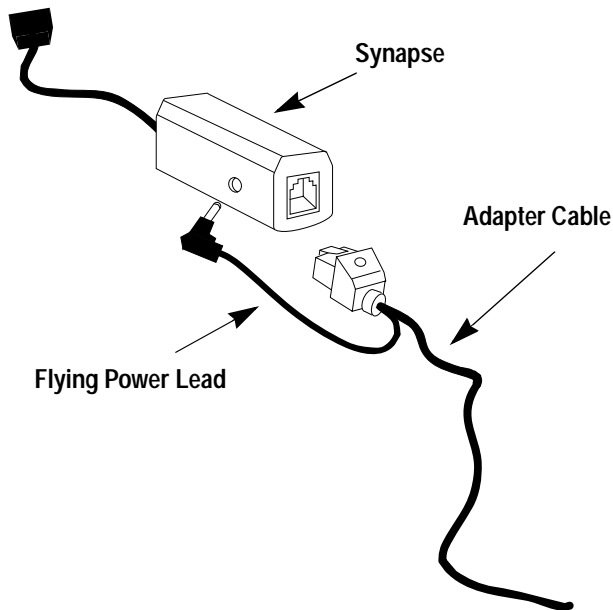

Figure 2-2. Synapse and Adapter Cable

5. Connect an appropriate power supply to the power receptacle on the base station. You will hear three beeps and the indicator light on the base station will blink, signifying successful power-up.

Charging the Battery

Before its first use, the LS 4071 batteries must be charged. To do so:

1. Connect the power supply to the power input jack on the RL 47X base station.
2. Connect the power supply to a receptacle supplying AC power of the proper voltage level.
3. Insert the scanner into the base station, so that the nose of the scanner and tip of the handle seat into the receptacles.

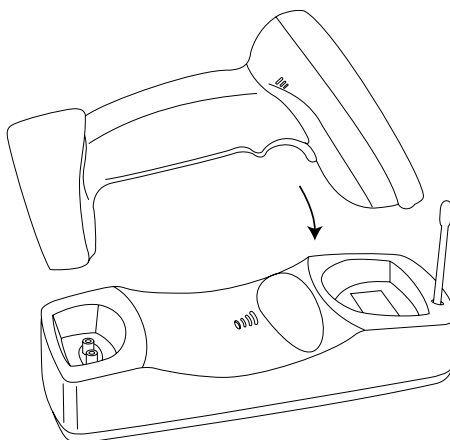

Figure 2-3. Placing the Scanner into the Base Station

4. Check the charge status indicator light. See table on page 4-6.
5. The battery pack will fully charge within 2 hours. When fully charged, proceed with pairing, as described on page 2-4.

As a charging stand, the base station recharges batteries in the scanner when the scanner is in the cradle. The status of the scanner battery module determines the charge rate. If the battery module is at or near full charge, the base station supplies a trickle charge. If the battery module is at less than full charge, there is a programmed charge. Note that the scanner can be removed from the base station at any time.



Battery Life

When batteries begin to run down, the scanner emits 4 high tone beeps. You then have about 10 scans remaining. Although NiCad batteries are rechargeable, they do have a limited life. In typical applications, the batteries should last about two years. As they begin to age, batteries do not hold a charge as long as when they were fresh; you have to charge them more often. New battery packs can be obtained from Symbol Technologies. See your Symbol representative for more information.

Pairing the Scanner with the Base Station

The wireless “connection” between the scanner and base is the low power radio transmission through an RF transmitter in the scanner, and an RF receiver in the base station. The actual communication consists of unidirectional message packets from the scanner to the base. However, **the scanner and base station must be paired** for this communication to work between the two devices.

Each base station is assigned a unique address in the factory. To pair the scanner with the base station:

- Scan the **PAIRING** bar code on the RL 47X base. The bar code is located in the well in which the scanner head rests. An additional pairing bar code can be found on the bottom of the base.
- Successful pairing is indicated by a warble beep from the scanner, then the base. If either beep is not heard, the pairing was unsuccessful.

The scanner and base should be configured with the same set of parameters. Scanning the bar code below ensures that the scanner’s parameters are sent to the base.



Connecting to a Host

With some terminal types, the LS 4071 is unable to answer host terminal polls until the appropriate host type is selected. This may result in an error message generated by the host. To correct this situation, select the proper parameter set and initialize the host terminal. See Chapter 2 for more information.

RS-232C

Plug the cable from the RL 474 base station into the appropriate port on the host device.

IBM 468X/9X

Plug the SDL modular connector at the end of the selected cable from the RL 475 base station into the appropriate port (5B, 9B, 9C, 9E, or 17). Check that the connection is secure. Note that the unit may be connected to one hardware port, and configured for a different software port via the bar code menus on page 5-8. The hardware ports determine how the unit is connected to the host, while the software port configuration determines how it communicates.

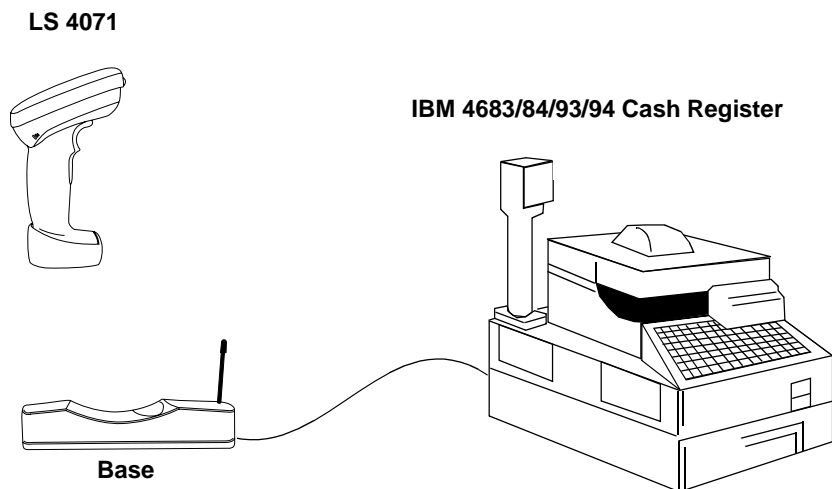

Figure 2-4. Typical System Configuration



IBM 468X/9X (Contd)

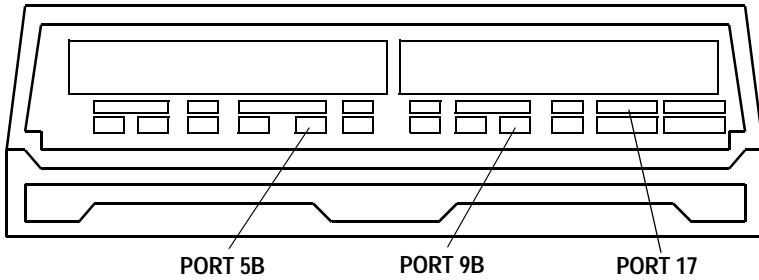

Figure 2-5. IBM 4683 Rear Panel With Cover Removed

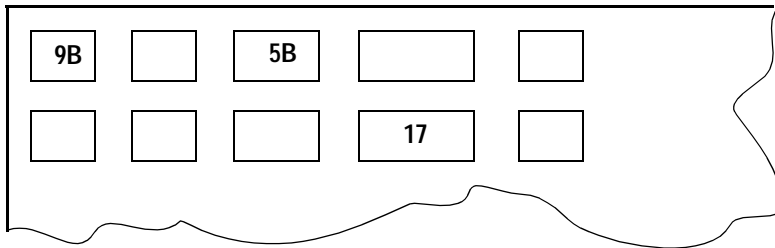

Figure 2-6. IBM 4684 Rear Panel With Cover Removed

IBM 468X/9X (Contd)

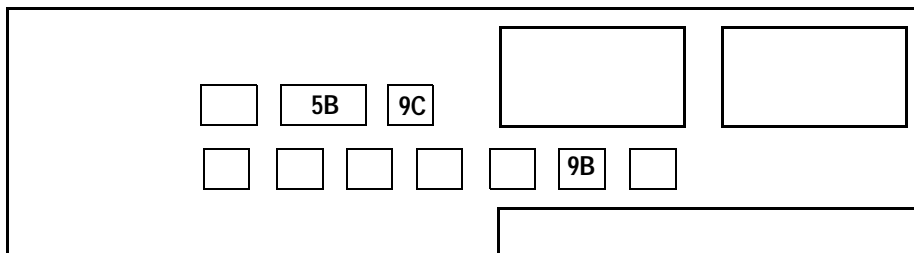

Figure 2-7. IBM 4693 Rear Panel With Cover Removed

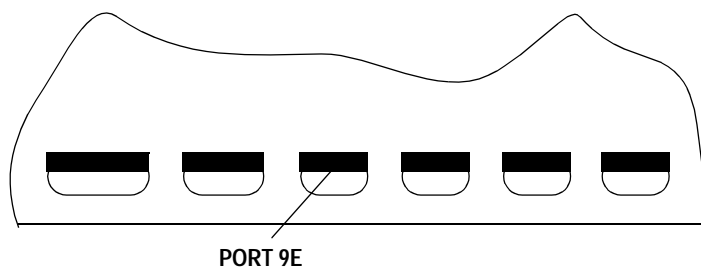
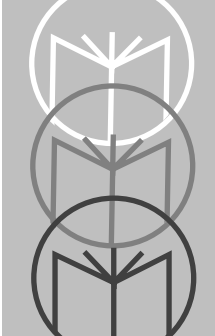

Figure 2-8. IBM 4694 Rear Panel With Cover Removed

Wand Emulation, OCIA, OCR, Keyboard Wedges

See the instructions packed with the appropriate Synapse cable. Adapter cable required. See Figure 2-2.





Chapter 3 Scanning

Ready, Test, Scan

1. Ready

Make sure connections are secure.

2. Test

Aim the scanner away from you and press the trigger. When you press the trigger, the scanning beam is energized for approximately 3.0 seconds (default).

3. Scan

Make sure the symbol you want to scan is within the scanning range. See the **LS 4071 Decode Zone** diagram on page 3-4.

The scanner has read the symbol when:

- The yellow LED on the rear of the scanner turns green for a short period of time after the scanning beam turns off.

The data has been successfully sent to the base station when:

- You hear a short, high tone beep from the base (if default beeper settings are selected).
- The yellow LED on the base blinks.



Aiming

Scan the Entire Symbol

- Your scan beam must cross every bar and space on the symbol.
- The larger the symbol, the farther away you should hold the scanner.
- Hold the scanner closer for symbols with bars that are close together.
- A short, high tone beep from the base indicates a good decode.



Hold at an Angle

Do not hold the scanner directly over the bar code. Laser light reflecting *directly* back into the scanner from the bar code is known as specular reflection. This strong light can “blind” the scanner and make decoding difficult. The area where specular reflection occurs is known as a “dead zone.”

You can tilt the scanner up to 65° forward or back and still achieve a successful decode. Simple practice quickly shows what tolerances to work within.

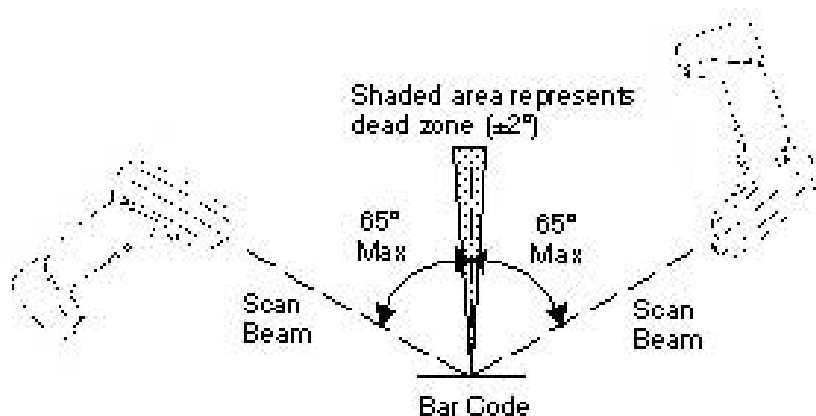

Figure 3-1. Maximum Tilt Angles and Dead Zone



LS 4071 Decode Zone

NOTE: Typical performance at 68° F (20° C) on high quality symbols.

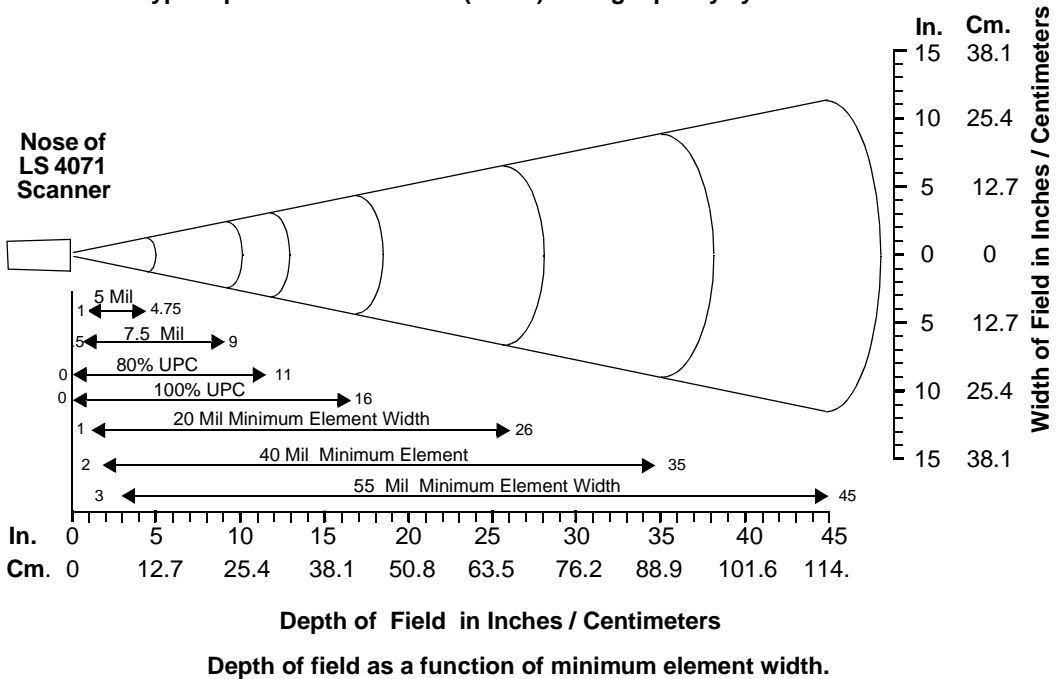

Figure 3-2. LS 4071 Decode Zone

What If...

Nothing happens when you follow the operating instructions?

You Should

- Check that the power supply is attached to the base station.
- Check for loose cable connections at the base station and host device.
- Check the scanner's battery pack.
- Make sure the device is programmed to read the type of bar code you want to scan.
- Check the symbol to make sure it is not defaced.
- Try scanning similar symbols of the same code type.
- Check that the "gas tank" is not exhausted.* Wait a few seconds, then try scanning. If the scanner works, allow sufficient time for the gas tank to fill before returning to normal usage.
- Make sure the scanner and base station have been successfully paired.
- Be sure you're within the proper scanning and transmission range.

**The gas tank limits the amount of time the laser remains on within a given period to conform to the requirements of IEC 825 Class 1.*

The base emits transmit errors (error beeps after decode).

You Should

- Check that the base station is powered up and that its cable connections are secure.
- Be sure the cable connection to the host is secure.
- Check that the appropriate host type is selected.



What If...

The base emits no beeps.

You Should

- Check that you are within scanning transmit range.
- Check that the scanner is successfully paired with the base station.
- Be sure the base is powered-up.

Note: If after performing these checks the symbol still does not scan, contact your distributor or call the Symbol Support Center. See page viii for the telephone number.

Programming the System

An LS 4071 is programmed by scanning sequences of bar codes; see Chapter 5.

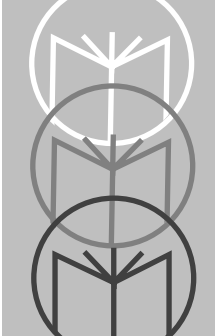

Chapter 4 Maintenance and Specifications

Maintenance

- Do not allow any abrasive material to touch the scanner window.
- Remove any dirt particles with a damp cloth.
- Wipe the scanner window using a damp cloth, and if necessary, a non-ammonia based detergent.
- Do not spray water or other cleaning liquids directly into the scanner window.
- If the contacts between the scanner and base become dirty, clean them with either a pencil eraser or a cotton swab dampened with alcohol.
- Change the battery pack when the batteries no longer provide 12 hours of scanning in typical usage. This should occur after 2 years or more, depending on your daily use.



Changing Battery Packs

Once a battery is fully charged, it will generally last up to 12 hours without being returned to the base. By returning it to the base during the day, you extend this time.

If you have a high volume environment and need fully charged batteries more often, you can charge other battery packs on the Universal Four-Slot Battery Charger. This way a charged battery pack is available when needed. In this case, simply remove the depleted battery pack and replace it with a freshly charged one.

User instructions are in the ***Universal Four-Slot Battery Charger Quick Reference Guide***.

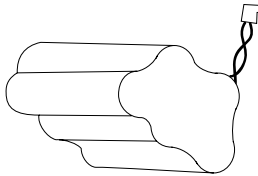

Figure 4-1. Battery Pack

To Change a Battery Pack:

1. Remove boot from lower handle of scanner.

Gently pull the boot from the back of the scanner. Avoid using sharp objects, as they might damage the boot. Slide the back of the boot off the scanner and remove by pushing forward.

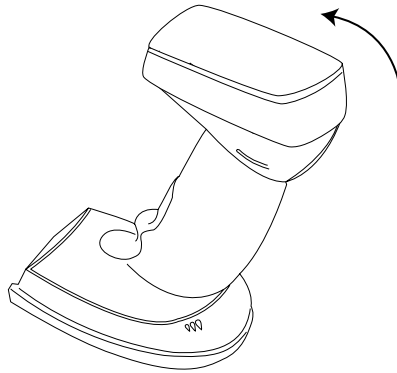

Figure 4-2. Removing the Boot

2. Remove battery compartment cover.

Slide the battery cover toward the back of the unit.

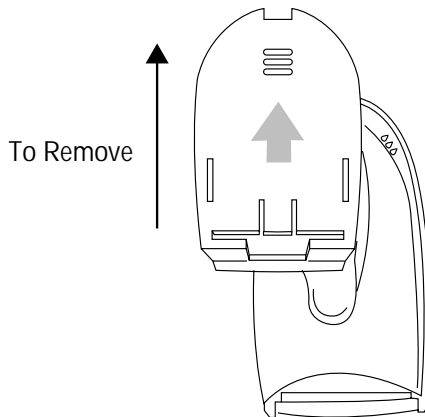

Figure 4-3. Removing the Battery Cover



3. Remove battery pack.

Remove the battery pack from its compartment. Disconnect it from the scanner. Do not remove the wire harness.

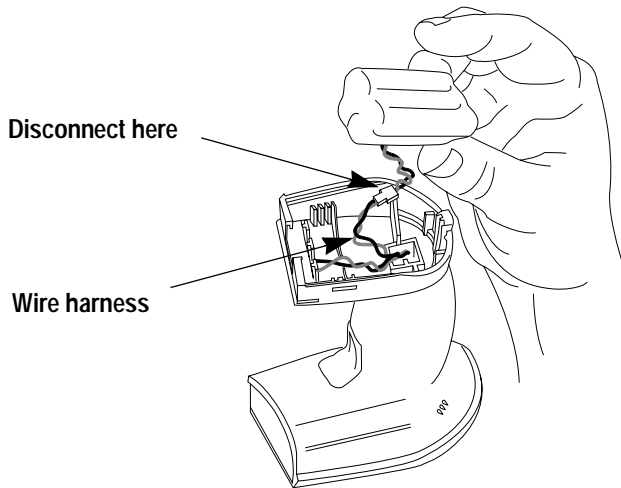

Figure 4-4. Removing the Battery Pack

4. Install new battery pack.

Connect the battery pack to the wire harness in the scanner. Place the battery pack in its compartment. Be careful not to crimp the wire between the battery pack and the ribs of the scanner.

5. Install battery pack cover.

Place the cover on the bottom of the scanner and gently push forward until it engages (snaps into place).

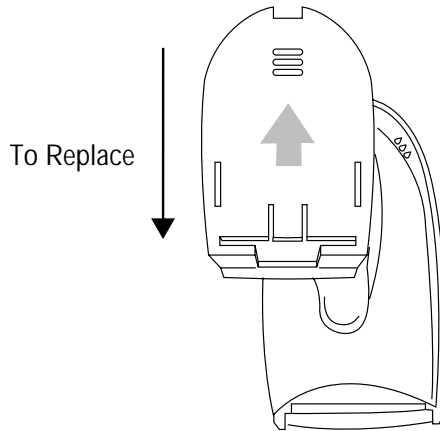

Figure 4-5. Replacing the Battery Cover

6. Re-install boot.

Slide boot onto the front of the base of the scanner. Be sure the charging contacts are visible through the front of the boot. Gently stretch the boot back into place.

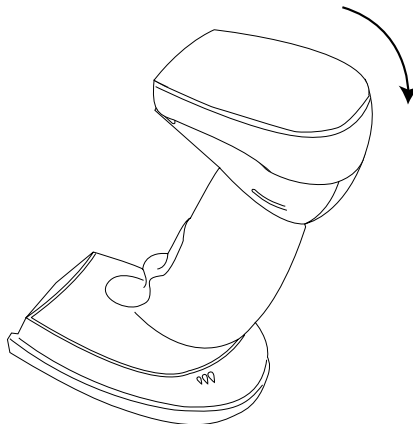

Figure 4-6. Replacing the Boot



Charge Status LED Indications

On the base station, there is a yellow LED indicator which uses flashing patterns to display the charger status, as shown in the table below.

Table 4-1. Charge Status LED Indications

Yellow LED	Status
Off	The scanner is not properly inserted or the battery is not functioning properly.
Blinking Slowly	The scanner is properly seated in the base station and trickle charging has begun.
Blinking Rapidly	The battery is actively fast charging. Charging will be complete in less than 1 hour.
On	Battery charging is complete.

Accessories

Required Accessories

LS 4071 scanners are sent as a package with required accessories, listed in the *Product Ordering Guide*. Optional accessories are available at extra cost.

Optional Accessories

Optional accessories, listed in the *Product Ordering Guide*, include various stands and holders, which are supplied at extra cost. Additional units of standard accessories may also be purchased at extra cost.



Technical Specifications

Table 4-2. Technical Specifications

Item	Description
Decode Capability	The LS 4071 can be programmed to decode the following code types: UPC/EAN, Bookland EAN, Code 39, Code 39 Full ASCII, Trioptic Code 39, Code 93, Codabar, Interleaved 2 of 5, Code 128, EAN 128, Discrete 2 of 5, and MSI Plessey. Set code length(s) for any linear code type. The LS 4071 can auto-discriminate between all of the above code types except for Code 39 and Code 39 Full ASCII. Transmission of decoded information depends on the capabilities of the attached terminal.
Beeper Operation (Base and Scanner)	User-selectable: Enabled, Disabled.
Scan Repetition Rate	36 (\pm 3) scans/sec (bidirectional)
Roll (Skew) Tolerance	\pm 25° from normal
Pitch	\pm 65° from normal
Yaw	\pm 60° from normal
Decode Depth of Field	See Decode Zone
Print Contrast Minimum	20% absolute dark/light differential, measured at the wavelength of the laser diode.
Ambient Light Immunity Artificial Lighting Sunlight	200 ft. candles 2153 lux 8000 ft. candles 86112 lux (@8 in. (20 cm) on low density bar codes)

Table 4-2. (Continued) Technical Specifications

Item	Description	
Operating Temperature	32° to 104°F	0° to 40°C
Storage Temperature	-40° to 140°F	-40° to 60°C
Humidity	5% to 95% (non-condensing)	
Durability (Scanner)	4-ft. drop to concrete	1.2 m
Dimensions	See figure below	
Laser Classifications	CDRH Class II IEC Class 1 IEC 825 Class 2	

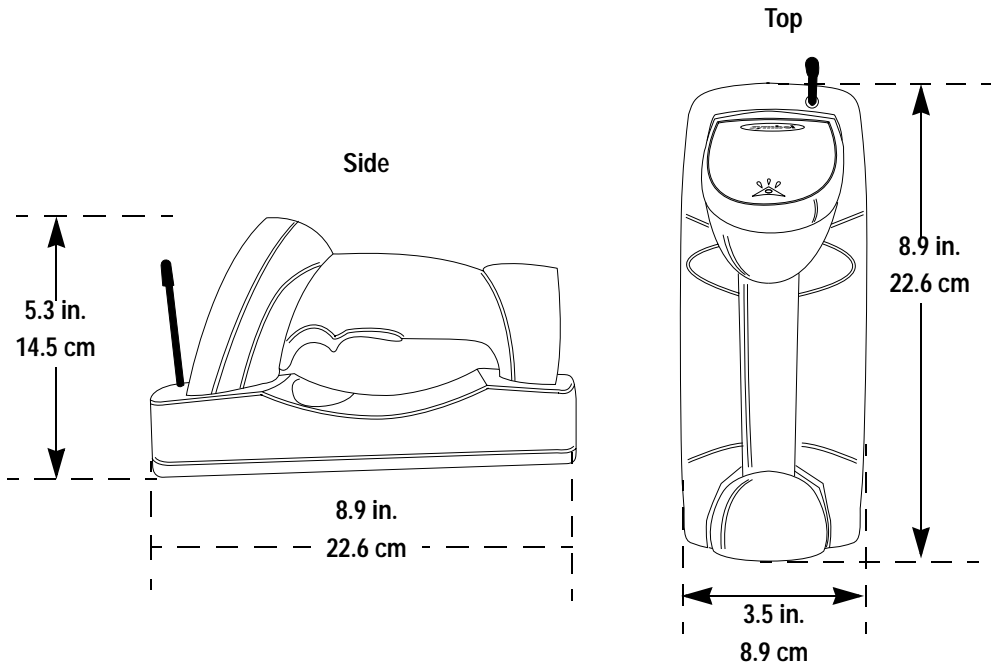

Figure 4-7. Scanner/Base Approximate Dimensions



Base Pin Outs

The following table shows the pin outs for each base station.

Table 4-3. Pin Outs

Pin	RL474	RL475
1	Reserved	Reserved
2	Power Out	Power Out
3	Ground	Ground
4	Synapse Data	Synapse Data
5	Synapse Clock	Synapse Clock
6	RxD	Not used
7	TxD	Not used
8	DTR	Not used
9	CTS	B IBM
10	RTS	A IBM

Beeper Indications

Table 4-4. Beeper Indications

Standard Use Beeper Sequence	Emitted From	Indication
Short high tone	Scanner & Base	A bar code symbol was decoded (if decode beeper is enabled).
4 Beeps - long low tone	Base	A transmission error has been detected in a scanned symbol. The data is ignored. This occurs if a unit is not properly configured. Check option settings.
5 Beeps - low tone	Base	Convert or format error.
Lo/hi/lo tone	Scanner	ADF transmit error.
Hi/hi/hi/lo tone	Base	RS-232 receive error.
4 Beeps - short hi	Scanner	Low battery.
3 Beeps - short hi	Base	Scanner/Base communications error. Rescan last bar code.
Parameter Menu Scanning		
Short high tone	Scanner	Correct entry scanned or correct menu sequence performed.
Lo/hi tone	Scanner	Input error, incorrect bar code or "Cancel" scanned, wrong entry, incorrect bar code programming sequence; remain in program mode.
Hi/lo tone	Scanner	Keyboard parameter selected. Enter value using bar code keypad.
Hi/lo/hi/lo tone	Scanner & Base	Successful program exit with change in the parameter setting.



Table 4-4. (Continued) Beeper Indications

Code 39 Buffering		
Hi/lo tone	Scanner	New Code 39 data was entered into the buffer.
3 Beeps - long high tone	Scanner	Code 39 buffer is full.
Lo/hi/lo tone	Scanner	The buffer was erased, or there was an attempt to transmit an empty buffer. When the Code 39 buffer was empty, the scanner read a command to clear or to transmit a Code 39 buffer.
4 Beeps - long low tone	Scanner	Error in data transmission.
Lo/hi tone	Scanner	A successful transmission of buffered data.

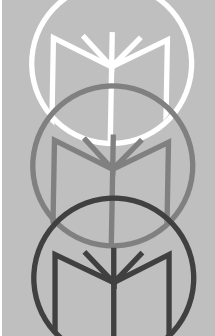

Chapter 5 Parameter Menus

Operational Parameters

The LS 4071 is shipped with the default settings beginning on page 5-2. These default values are stored in non-volatile memory and are preserved even when the scanner is powered down. You can change these default values by scanning the appropriate bar codes included in this manual. These new values replace the standard default values in memory. The default parameter values can be recalled by scanning the **SET ALL DEFAULTS** bar code on page 5-7.

Even if the default parameters suit your needs, you still must select a terminal type. The base automatically identifies the host type on power-up. It makes this determination provided the host is powered-up before the base is attached to it. You must then select the appropriate terminal type for that host. For example, if the base is connected to an IBM 4683, after you hear the power-up beeps, you must then select the proper port. The same applies to all other host types.



The following table lists the defaults for all parameters. If you wish to change any option, scan the appropriate bar code(s).

Table 5-1. Default Table

Parameter	Default	Page Number
Set Default Parameter	All Defaults	5-7
Host Type	See page 5-1	5-8
Beeper Tone	High Frequency	5-12
Beeper Volume	High	5-13
Laser On Time	3.0 seconds	5-14
Base Beep After Good Decode	Enable	5-15
Scanner Beep After Good Decode	Disable	5-16
Base Beep Type	Beep 1	5-17
Transmit "No Read" Message	Disable	5-18
Linear Code Type Security Levels	1	5-19
Bi-directional Redundancy	Disable	5-22
UPC/EAN		
UPC-A	Enable	5-23
UPC-E	Enable	5-23
EAN-8	Enable	5-24
EAN-13	Enable	5-24
Bookland EAN	Disable	5-25
Decode UPC/EAN Supplementals	Ignore	5-26
Decode UPC/EAN Supplemental Redundancy	7	5-27

Table 5-1. Default Table

Parameter	Default	Page Number
Transmit UPC-A Check Digit	Enable	5-28
Transmit UPC-E Check Digit	Enable	5-28
UPC-A Preamble	System Character	5-29
UPC-E Preamble	System Character	5-30
Convert UPC-E to A	Disable	5-31
EAN-8 Zero Extend	Disable	5-32
Convert EAN-8 to EAN-13 Type	Type is EAN-13	5-33
UPC/EAN Security Levels	0	5-34
UPC/EAN Coupon Code	Disable	5-36
Code 128		
Code 128	Enable	5-37
UCC/EAN-128	Disable	5-38
Code 39		
Code 39	Enable	5-40
Trioptic Code 39	Disable	5-41
Set Length(s) for Code 39	2 to 55	5-43
Code 39 Check Digit Verification	Disable	5-44
Transmit Code 39 Check Digit	Disable	5-45
Code 39 Full ASCII Conversion	Disable	5-46
Buffer Code 39	Disable	5-47
Convert Code 39 to Code 32	Disable	5-50



Table 5-1. Default Table

Parameter	Default	Page Number
Code 93		
Code 93	Disable	5-51
Set Length(s) for Code 93	4-55	5-52
Interleaved 2 of 5		
Interleaved 2 of 5	Enable	5-54
Set Length(s) for I 2 of 5	14	5-55
I 2 of 5 Check Digit Verification	Disable	5-57
Transmit I 2 of 5 Check Digit	Disable	5-58
Convert I 2 of 5 to EAN 13	Disable	5-59
Discrete 2 of 5		
Discrete 2 of 5	Disable	5-60
Set Length(s) for D 2 of 5	12	5-61
Codabar		
Codabar	Disable	5-63
Set Lengths for Codabar	5-55	5-65
CLSI Editing	Disable	5-66
NOTIS Editing	Disable	5-67

Table 5-1. Default Table

Parameter	Default	Page Number
MSI Plessey		
MSI Plessey	Disable	5-68
Set Length(s) for MSI Plessey	Any Length	5-70
MSI Plessey Check Digits	One	5-71
Transmit MSI Plessey Check Digit	Disable	5-72
MSI Plessey Check Digit Algorithm	Mod 10/Mod 10	5-73
Data Options		
Transmit Code ID Character	None	5-75
Pause Duration	0	5-76
Prefix/Suffix Values	7013 (<CR/LF> for serial)	5-77
Scan Data Transmission Format	Data as is	5-78
Transmit ASCII/Intermediate Data	ASCII Data	5-80



Table 5-1. Default Table

Parameter	Default	Page Number
RS-232C		
RS-232 Host Type	Standard	5-11
Baud Rate	9600	5-82
Parity	None	5-83
Check Receive Errors	Disable	5-85
Hardware Handshaking	None	5-87
Software Handshaking	None	5-89
Host Serial Response Time-out	2 Sec.	5-92
RTS Line State	Low	5-93
Stop Bit Select	1	5-94
ASCII Format	8-Bit	5-95
Beep on <BEL>	Disable	5-96
Intercharacter Delay	0	5-97

Set Default Parameter

Scanning this bar code returns all parameters to the values listed in the default table beginning on page 5-2.



SET ALL DEFAULTS



Host Type

IBM 46XX Host Types

To select one of the following as a POS Interface, scan the appropriate bar code below.

Note: To properly communicate with 468X/9X terminals, the driver corresponding to the port being used must be loaded and enabled when you are configuring your terminal system. See your terminal's operating manual for details.



Port 5B



Port 9B



Port 17

Host Type

RS-232C Host Types

Three RS-232C hosts are set up with their own parameter default settings. Selecting the ICL, Fujitsu or Nixdorf RS-232C terminal sets the defaults listed below. These defaults take precedence over Standard RS-232 defaults. So, if you've selected Fujitsu RS-232C, then select the Standard RS-232 defaults, the Fujitsu defaults still take precedence. To return to the factory set defaults, scan the **SET ALL DEFAULTS** bar code on page 5-7.

Table 5-2. Terminal Specific RS-232C

Parameter	Standard	ICL	FUJITSU	NIXDORF Mode A/ Mode B
Transmit Code ID	No	Yes	Yes	Yes
Data Transmission Format	Data as is	Data/Suffix	Data/Suffix	Data/Suffix
Suffix	CR/LF	CR	CR	CR
Baud Rate	9600	9600	9600	9600
Parity	None	Even	None	Odd
Hardware Handshaking	None	RTS/CTS Option 3	None	RTS/CTS Option 3
Software Handshaking	None	None	None	None
Serial Response Time-out	2 Sec.	9.9 Sec.	2 Sec.	9.9 Sec.
Stop Bit Select	One	One	One	One
ASCII Format	8-Bit	8-Bit	8-Bit	8-Bit
Beep On <BEL>	Disabled	Disabled	Disabled	Disabled
RTS Line State	Low	High	Low	*Low = No data to send

*In the Nixdorf Mode B, if CTS is Low, transmission of scan data is disabled. When CTS is High, bar code data is transmitted to the host.



Host Type

RS-232C Host Types

Selecting the ICL, Fujitsu, or Nixdorf RS-232C terminal enables the transmission of Code ID Characters as listed below. These Code ID Characters are not programmable and are separate from the Transmit Code ID feature. The Transmit Code ID feature should not be enabled for these terminals.

Table 5-3. Terminal Specific Code ID Characters

	ICL	FUJITSU	NIXDORF
UPC-A	"A"	"A"	"A"
UPC-E	"E"	"E"	"C0"
EAN-8	"FF"	"FF"	"B"
EAN-13	"F"	"F"	"A"
Code 39	"C" <len>	None	"M"
Codabar	"N" <len>	None	"N"
Code 128	"L" <len>	None	"K"
I 2 of 5	"I" <len>	None	"I"
Code 93	None	None	"L"
D 2 of 5	"H" <len>	None	"H"
UCC/EAN 128	"L" <len>	None	"P"
MSI/Plessey	None	None	"O"
Bookland EAN	"F"	"F"	"A"
Trioptic	None	None	None

Host Type

RS-232C Host Types

To select an RS-232C Host Interface, scan one of the following bar codes.



STANDARD RS-232C



ICL RS-232C



NIXDORF RS-232C Mode A



NIXDORF RS-232C Mode B



FUJITSU RS-232C



Beeper Tone

To select a decode beep frequency (tone), scan the **LOW FREQUENCY**, **MEDIUM FREQUENCY**, or **HIGH FREQUENCY** bar code.

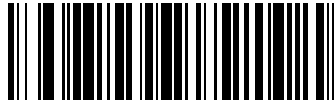

LOW FREQUENCY

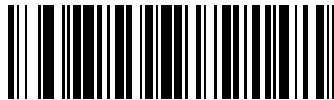

MEDIUM FREQUENCY

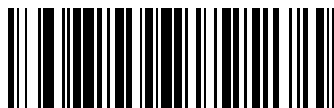

HIGH FREQUENCY

Beeper Volume

To select a beeper volume, scan the **LOW VOLUME**, **MEDIUM VOLUME**, or **HIGH VOLUME** bar code. This selection affects the scanner beeper, base beeper, or both if so selected.



LOW VOLUME



MEDIUM VOLUME



HIGH VOLUME



Laser On Time

This parameter sets the maximum time decode processing continues during a scan attempt. It is programmable in 0.1 second increments from 0.5 to 9.9 seconds.

To set a Laser On Time, scan the bar code below. Next scan two numeric bar codes beginning on page 5-98 that correspond to the desired time on. Time less than 1.0 second must have a leading zero. For example, to set a Time On of .5 seconds, scan the bar code below, then scan the “0” and “5” bar codes. If you make an error, or wish to change your selection, scan **CANCEL** on page 5-100



LASER ON TIME

Base Beep After Good Decode

Scan this symbol if you want the base unit to beep after a good decode.



BASE BEEP AFTER GOOD DECODE

Do Not Beep After Good Decode

Scan this symbol if you do not want the base unit to beep after a good decode. The beeper still operates during parameter menu scanning and indicates error conditions.



DO NOT BEEP AFTER GOOD DECODE



Scanner Beep After Good Decode

Scan this symbol if you want the scanner to beep after a good decode.



SCANNER BEEP AFTER GOOD DECODE

Do Not Beep After Good Decode

Scan this symbol if you want the scanner not to beep after a good decode. The beeper still operates during parameter menu scanning and indicates error conditions.



DO NOT BEEP AFTER GOOD DECODE

Base Beep Type

Select the type of beep for the base unit. This parameter is useful when two or more systems are installed in proximity to each other. Unique beep patterns can be set up to distinguish each system's receipt of bar code data.



Beep 1



Beep 2



Beep 3



Beep 4



Beep 5



Transmit “No Read” Message

When enabled, if a symbol does not decode, “NR” is transmitted. Any prefixes or suffixes which have been enabled are appended around this message.



ENABLE NO READ

Do Not Transmit “No Read” Message

When disabled, if a symbol does not read, nothing is sent to the host.



DISABLE NO READ

Linear Code Type Security Level

(Does not apply to Code 128)

The LS 4071 offers four levels of decode security for linear code types (e.g. Code 39, Interleaved 2 of 5). Higher security levels are selected for decreasing levels of bar code quality. As security levels increase, the scanner's aggressiveness decreases.

Select the security level appropriate for your bar code quality.

Linear Security Level 1

The following code types must be successfully read twice before being decoded:

Code Type	Length
Codabar	All
MSI Plessey	4 or less
D 2 of 5	8 or less
I 2 of 5	8 or less

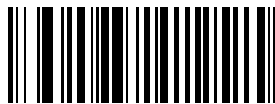

LINEAR SECURITY LEVEL 1



Linear Code Type Security Level (Cont'd)

Linear Security Level 2

The following code types must be successfully read twice before being decoded:

Code Type	Length
All	All

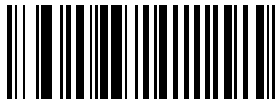

LINEAR SECURITY LEVEL 2

Linear Security Level 3

Code types other than the following must be successfully read twice before being decoded. The following codes must be read three times:

Code Type	Length
MSI Plessey	4 or less
D 2 of 5	8 or less
I 2 of 5	8 or less

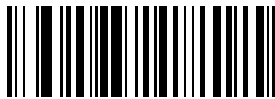

LINEAR SECURITY LEVEL 3

Linear Code Type Security Level (Cont'd)

Linear Security Level 4

The following code types must be successfully read three times before being decoded:

Code Type	Length
All	All

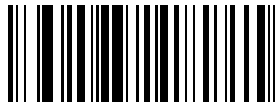

LINEAR SECURITY LEVEL 4



Bi-directional Redundancy

This parameter is only valid when a **Linear Code Type Security Level** (see page 5-19) is enabled. When this parameter is enabled, a bar code must be successfully scanned in both directions (forward and reverse) before being decoded.



ENABLE BI-DIRECTIONAL REDUNDANCY



DISABLE BI-DIRECTIONAL REDUNDANCY

Enable/Disable UPC-E/UPC-A

To enable or disable UPC-E or UPC-A, scan the appropriate bar code below.

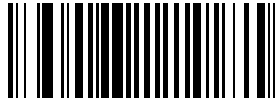

ENABLE UPC-E

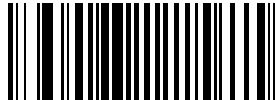

DISABLE UPC-E

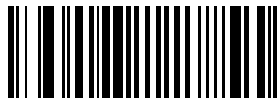

ENABLE UPC-A



DISABLE UPC-A



Enable/Disable EAN-8/EAN-13

To enable or disable EAN-8 or EAN-13, scan the appropriate bar code below.

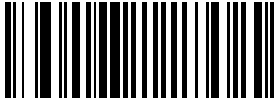

ENABLE EAN-8



DISABLE EAN-8

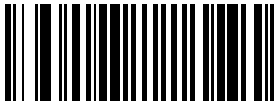

ENABLE EAN-13



DISABLE EAN-13

Enable/Disable Bookland EAN

To enable or disable EAN Bookland, scan the appropriate bar code below.



ENABLE BOOKLAND EAN



DISABLE BOOKLAND EAN



Decode UPC/EAN Supplementals

Supplementals are additionally appended characters (2 or 5) according to specific code format conventions (e.g., UPC A+2, UPC E+2, EAN 8+2). Three options are available.

- If UPC/EAN with supplemental characters is selected, UPC/EAN symbols without supplemental characters are not decoded.
- If UPC/EAN without supplemental characters is selected, and the LS 4071 is presented with a UPC/EAN plus supplemental symbol, the UPC/EAN is decoded and the supplemental characters ignored.
- An autodiscriminate option is also available. If this option is selected, choose an appropriate **Decode UPC/EAN Supplemental Redundancy** value from the next page. A value of 5 or more is recommended.

Note: To minimize the risk of invalid data transmission, select whether to read or ignore supplemental characters.

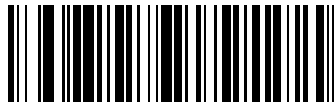

DECODE UPC/EAN WITH SUPPLEMENTALS

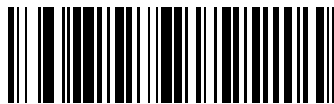

IGNORE UPC/EAN WITH SUPPLEMENTALS

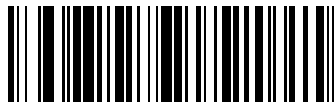

AUTODISCRIMINATE UPC/EAN SUPPLEMENTALS

Decode UPC/EAN Supplemental Redundancy

With Autodiscriminate UPC/EAN Supplementals selected, this option adjusts the number of times a symbol without supplementals is decoded before transmission. The range is from two to 20 times. Five or above is recommended when decoding a mix of UPC/EAN symbols with and without supplementals, and the autodiscriminate option is selected.

Scan the bar code below to select a decode redundancy value. Next scan two numeric bar codes beginning on page 5-98. Single digit numbers must have a leading zero. If you make an error, or wish to change your selection, scan CANCEL on page 5-100.

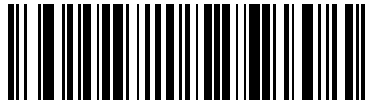

DECODE UPC/EAN
SUPPLEMENTAL REDUNDANCY



Transmit UPC-A/UPC-E Check Digit

Scan the appropriate bar code below to transmit the symbol with or without the UPC-A or UPC-E check digit.

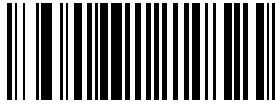

TRANSMIT UPC-A CHECK DIGIT

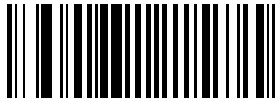

DO NOT TRANSMIT UPC-A CHECK DIGIT

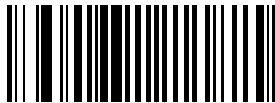

TRANSMIT UPC-E CHECK DIGIT



DO NOT TRANSMIT UPC-E CHECK DIGIT

UPC-A Preamble

Three options are given for lead-in characters for UPC-A symbols transmitted to the host device: transmit system character only, transmit system character and country code (“0” for USA), and no preamble transmitted. The lead-in characters are considered part of the symbol.

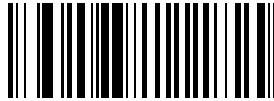

NO PREAMBLE
(<DATA>)

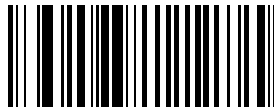

SYSTEM CHARACTER
(<SYSTEM CHARACTER> <DATA>)

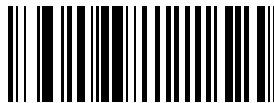

SYSTEM CHARACTER & COUNTRY CODE
(< COUNTRY CODE> <SYSTEM CHARACTER> <DATA>)



UPC-E Preamble

Three options are given for lead-in characters for UPC-E symbols transmitted to the host device: transmit system character only, transmit system character and country code (“0” for USA), and no preamble transmitted. The lead-in characters are considered part of the symbol.

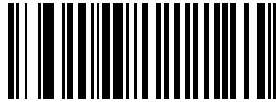

NO PREAMBLE
(<DATA>)

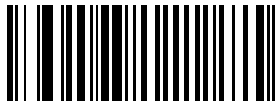

SYSTEM CHARACTER
(<SYSTEM CHARACTER> <DATA>)



SYSTEM CHARACTER & COUNTRY CODE
(< COUNTRY CODE> <SYSTEM CHARACTER> <DATA>)

Convert UPC-E to UPC-A

This parameter converts UPC-E (zero suppressed) decoded data to UPC-A format before transmission. After conversion, data will follow UPC-A format and be affected by UPC-A programming selections (e.g., Preamble, Check Digit).

Scanning **DO NOT CONVERT UPC-E TO UPC-A** allows you to transmit UPC-E (zero suppressed) decoded data.

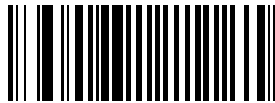

CONVERT UPC-E TO UPC-A
(ENABLE)

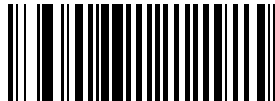

DO NOT CONVERT UPC-E TO UPC-A
(DISABLE)



EAN Zero Extend

If this parameter is enabled, five leading zeros are added to decoded EAN-8 symbols to make them compatible in format to EAN-13 symbols.

Disabling this parameter returns EAN-8 symbols to their normal format.

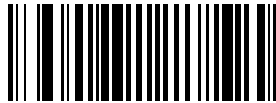

ENABLE EAN ZERO EXTEND

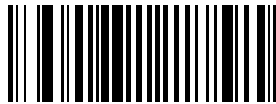

DISABLE EAN ZERO EXTEND

Convert EAN-8 to EAN-13 Type

When EAN Zero Extend is enabled, this parameter gives you the option of labeling the extended symbol as either an EAN-13 bar code, or an EAN-8 bar code.

When EAN Zero Extend is disabled, this parameter has no effect on bar code data.



TYPE IS EAN-13



TYPE IS EAN-8



UPC/EAN Security Level

The LS 4071 offers four levels of decode security for UPC/EAN bar codes. Increasing levels of security are provided for decreasing levels of bar code quality. There is an inverse relationship between security and scanner aggressiveness, so be sure to choose only that level of security necessary for any given application.

UPC/EAN Security Level 0

This is the default setting which allows the scanner to operate in its most aggressive state, while providing sufficient security in decoding “in-spec” UPC/EAN bar codes.

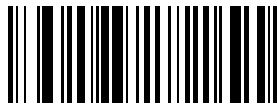

UPC/EAN SECURITY LEVEL 0

UPC/EAN Security Level 1

As bar code quality levels diminish, certain characters become prone to mis-decodes before others (i.e., 1, 2, 7, 8). If you are experiencing mis-decodes of poorly printed bar codes, and the mis-decodes are limited to these characters, select this security level.

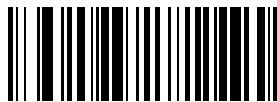

UPC/EAN SECURITY LEVEL 1

UPC/EAN Security Level (Cont'd)

UPC/EAN Security Level 2

If you are experiencing mis-decodes of poorly printed bar codes, and the mis-decodes are not limited to characters 1, 2, 7, and 8, select this security level.

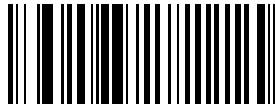

UPC/EAN SECURITY LEVEL 2

UPC/EAN Security Level 3

If you have tried Security Level 2, and are still experiencing misdecodes, select this security level. Be advised that selecting this option is an extreme measure against mis-decoding severely out of spec bar codes. Selection of this level of security significantly impairs the decoding ability of the scanner. If this level of security is necessary, you should try to improve the quality of your bar codes.

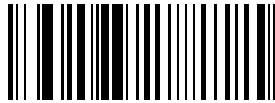

UPC/EAN SECURITY LEVEL 3



UPC/EAN Coupon Code

When enabled, this parameter will decode UPC-A, UPC-A with 2 supplemental characters, UPC-A with 5 supplemental characters, and UPC-A/EAN128 bar codes. UPC-A with supplemental characters need not be enabled.



ENABLE UPC/EAN COUPON CODE



DISABLE UPC/EAN COUPON CODE

Enable/Disable Code 128

To enable or disable Code 128, scan the appropriate bar code below.

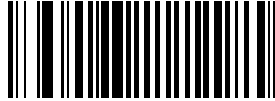

ENABLE CODE 128

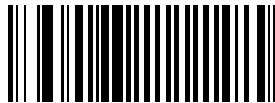

DISABLE CODE 128



Enable/Disable UCC/EAN-128

To enable or disable UCC/EAN-128, scan the appropriate bar code below. (See *Appendix A* for details on UCC/EAN-128.)



ENABLE UCC/EAN-128

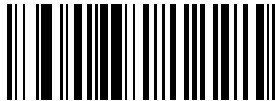

DISABLE UCC/EAN-128

Lengths for Code 128

No length setting is required for Code 128. The default setting is Any Length.



Enable/Disable Code 39

To enable or disable Code 39, scan the appropriate bar code below.

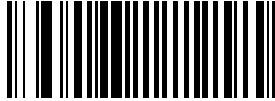

ENABLE CODE 39

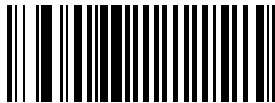

DISABLE CODE 39

Enable/Disable Trioptic Code 39

Trioptic Code 39 symbols always contain six characters. Trioptic Code 39 and Code 39 Full ASCII cannot be enabled simultaneously. If you get an error beep when enabling Trioptic Code 39, disable Code 39 Full ASCII and try again. To enable or disable Trioptic Code 39, scan the appropriate bar code below.



ENABLE TRIOPTIC CODE 39



DISABLE TRIOPTIC CODE 39



Set Lengths for Code 39

Lengths for Code 39 may be set for any length, one or two discrete lengths, or lengths within a specific range. The length of a code refers to the number of characters (i.e., human readable characters), including check digit(s) the code contains. If Code 39 Full ASCII is enabled, **Length Within a Range** or **Any Length** are the preferred options.

One Discrete Length - This option allows you to decode only those codes containing a selected length. For example, if you select **Code 39 One Discrete Length**, then scan **1, 4**, only Code 39 symbols containing 14 characters are decoded. Numeric bar codes begin on page 5-98. If you make an error, or wish to change your selection, scan **CANCEL** on page 5-100.



CODE 39 - ONE DISCRETE LENGTH

Two Discrete Lengths - This option allows you to decode only those codes containing two selected lengths. For example, if you select **Code 39 Two Discrete Lengths**, then scan **0, 2, 1, 4**, only Code 39 symbols containing 2 or 14 characters are decoded. Numeric bar codes begin on page 5-98. If you make an error, or wish to change your selection, scan **CANCEL** on page 5-100.

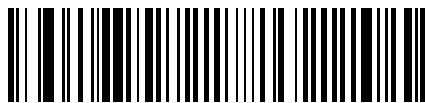

CODE 39 - TWO DISCRETE LENGTHS

Set Lengths for Code 39 (Cont'd)

Length Within Range - This option allows you to decode a code type within a specified range. For example to decode Code 39 symbols containing between 4 and 12 characters, first scan **Code 39 Length Within Range**. Then scan **0, 4, 1** and **2** (single digit numbers must always be preceded by a leading zero). Numeric bar codes begin on page 5-98. If you make an error, or wish to change your selection, scan **CANCEL** on page 5-100.



CODE 39 - LENGTH WITHIN RANGE

Any Length - Scanning this option allows you to decode Code 39 symbols containing any number of characters.



CODE 39 - ANY LENGTH



Code 39 Check Digit Verification

When enabled, this parameter checks the integrity of a Code 39 symbol to ensure it complies with specified algorithms.

Only those code 39 symbols which include a modulo 43 check digit are decoded when this parameter is enabled.



ENABLE CODE 39 CHECK DIGIT



DISABLE CODE 39 CHECK DIGIT

Transmit Code 39 Check Digit

Scan this symbol if you want to transmit the check digit with the data.



TRANSMIT CODE 39 CHECK DIGIT
(ENABLE)

Do Not Transmit Code 39 Check Digit

Scan this symbol if you want to transmit the data without the check digit.



DO NOT TRANSMIT CODE 39 CHECK DIGIT
(DISABLE)



Enable/Disable Code 39 Full ASCII

To enable or disable Code 39 Full ASCII, scan the appropriate bar code below.

When enabled, the ASCII character set assigns a code to letters, punctuation marks, numerals, and most control keystrokes on the keyboard.

The first 32 codes are non-printable and are assigned to keyboard control characters such as BACKSPACE and RETURN. The other 96 are called printable codes because all but SPACE and DELETE produce visible characters.

Code 39 Full ASCII interprets the bar code special character (\$ + % /) preceding a Code 39 character and assigns an ASCII character value to the pair. For example, when Code 39 Full ASCII is enabled and a +**B** is scanned, it is interpreted as **b**, %**J** as **?**, and \$**H** emulates the keystroke **BACKSPACE**. Scanning **ABC\$M** will output the keystroke equivalent of **ABC ENTER**. Refer to the ASCII table in *Appendix A*.

Code 39 Full ASCII and Trioptic Code 39 cannot be enabled simultaneously. If you get an error beep when enabling Code 39 Full ASCII, disable Trioptic Code 39 and try again.

The scanner does not autodiscriminate between Code 39 and Code 39 Full ASCII.

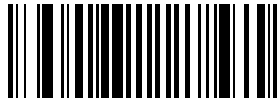

ENABLE CODE 39 FULL ASCII

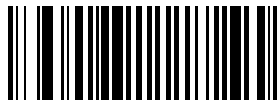

DISABLE CODE 39 FULL ASCII

Code 39 Buffering (Scan & Store)

When you select the scan and store option, all Code 39 symbols having a leading space as a first character are temporarily buffered in the unit to be transmitted later. The leading space is not buffered.

Decode of a valid Code 39 symbol with no leading space causes transmission in sequence of all buffered data in a first-in first-out format, plus transmission of the “triggering” symbol. See the following pages for further details.

When the scan and transmit option is selected, decoded Code 39 symbols without leading spaces are transmitted without being stored in the buffer.

Scan and Store affects Code 39 decodes only. If you select scan and store, it is recommended that you configure the scanner to decode Code 39 symbology only.



**BUFFER CODE 39
(ENABLE)**



**DO NOT BUFFER CODE 39
(DISABLE)**



Code 39 Buffering (Scan & Store)

While there is data in the transmission buffer, deleting Code 39 buffering capability via the parameter menu is not allowed. The buffer holds 200 bytes of information.

To allow disabling of Code 39 buffering, first force the buffer transmission (see **Transmit Buffer**) or clear the buffer. Both the **CLEAR BUFFER** and **TRANSMIT BUFFER** bar codes are length 1. *Be sure Code 39 length is set to include length 1.*

Buffer Data

To buffer data, Code 39 buffering must be enabled, and a symbol must be read with a space immediately following the start pattern.

- Unless symbol overflows the transmission buffer, the unit gives lo/hi beep to indicate successful decode and buffering. See **Overfilling Transmission Buffer**.
- Unit adds the message, excluding the leading space to the transmission buffer.
- No transmission occurs.

Clear Transmission Buffer

To clear the transmission buffer, read a symbol which contains only a start character, a dash (minus), and a stop character.

- Unit issues a short hi/lo/hi beep to signal that the transmission buffer has been erased, and no transmission has occurred.
- Unit erases the transmission buffer.
- No transmission occurs.



CLEAR BUFFER

Code 39 Buffering (Scan & Store)

Transmit Buffer

To transmit the buffer, read a symbol containing either the first or second condition:

1. Only a start character, a plus (+), and a stop character.
 - The unit signals that the transmission buffer has been sent (a lo/hi beep).
 - Unit sends the buffer.
 - Unit clears the buffer.



TRANSMIT BUFFER

2. A Code 39 bar code with leading character other than a space.
 - The unit signals a good decode and buffering of that decode has occurred by giving a hi/lo beep.
 - Unit transmits the buffer.
 - Unit signals that the buffer has been transmitted with a lo/hi beep.

Overfilling Transmission Buffer

If the symbol just read will result in an overflow of the transmission buffer:

- Unit indicates that the symbol has been rejected by issuing three long, high beeps.
- No transmission occurs. Data in buffer is not affected.

Attempt to Transmit an Empty Buffer

If the symbol just read was the transmit buffer symbol and the Code 39 buffer is empty:

- A short lo/hi/lo beep signals that the buffer is empty.
- No transmission occurs.
- The buffer remains empty.



Convert Code 39 to Code 32

Scan this symbol if you want to convert Code 39 to Code 32.



CONVERT CODE 39 TO CODE 32
(ENABLE)

Note: Code 39 must be enabled in order for this parameter to function.

Do Not Convert Code 39 to Code 32

Scan this symbol if you do not want to convert Code 39 to Code 32.



DO NOT CONVERT CODE 39 TO CODE 32
(DISABLE)

Enable/Disable Code 93

To enable or disable Code 93, scan the appropriate bar code below.



ENABLE CODE 93



DISABLE CODE 93



Set Lengths for Code 93

Lengths for Code 93 may be set for any length, one or two discrete lengths, or lengths within a specific range. The length of a code refers to the number of characters (i.e., human readable characters), including check digit(s) the code contains.

One Discrete Length - This option allows you to decode only those codes containing a selected length. For example, if you select **Code 93 One Discrete Length**, then scan **1, 4**, only Code 93 symbols containing 14 characters are decoded. Numeric bar codes begin on page 5-98. If you make an error, or wish to change your selection, scan **CANCEL** on page 5-100.



CODE 93 - ONE DISCRETE LENGTH

Two Discrete Lengths - This option allows you to decode only those codes containing two selected lengths. For example, if you select **Code 93 Two Discrete Lengths**, then scan **0, 2, 1, 4**, only Code 93 symbols containing 2 or 14 characters are decoded. Numeric bar codes begin on page 5-98. If you make an error, or wish to change your selection, scan **CANCEL** on page 5-100.



CODE 93 - TWO DISCRETE LENGTHS

Set Lengths for Code 93 (Cont'd)

Length Within Range - This option allows you to decode a code type within a specified range. For example to decode Code 93 symbols containing between 4 and 12 characters, first scan **Code 93 Length Within Range**. Then scan **0, 4, 1** and **2** (single digit numbers must always be preceded by a leading zero). Numeric bar codes begin on page 5-98. If you make an error, or wish to change your selection, scan **CANCEL** on page 5-100.



CODE 93 - LENGTH WITHIN RANGE

Any Length - Scanning this option allows you to decode Code 93 symbols containing any number of characters.



CODE 93 - ANY LENGTH



Enable/Disable Interleaved 2 of 5

To enable or disable Interleaved 2 of 5, scan the appropriate bar code below.

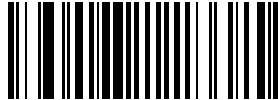

ENABLE INTERLEAVED 2 OF 5

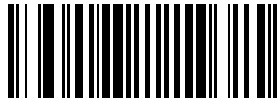

DISABLE INTERLEAVED 2 OF 5

Set Lengths for Interleaved 2 of 5

Lengths for I 2 of 5 may be set for any length, one or two discrete lengths, or lengths within a specific range. The length of a code refers to the number of characters (i.e., human readable characters) the code contains and includes check digits.

One Discrete Length - This option allows you to decode only those codes containing a selected length. For example, if you select **I 2 of 5 One Discrete Length**, then scan **1, 4**, the only I 2 of 5 symbols decoded are those containing 14 characters. Numeric bar codes begin on page 5-98. If you make an error, or wish to change your selection, scan **CANCEL** on page 5-100.



I 2 of 5 - ONE DISCRETE LENGTH

Two Discrete Lengths - This option allows you to decode only those codes containing two selected lengths. For example, if you select **I 2 of 5 Two Discrete Lengths**, then scan **0, 2, 1, 4**, the only I 2 of 5 symbols decoded are those containing 2 or 14 characters. Numeric bar codes begin on page 5-98. If you make an error, or wish to change your selection, scan **CANCEL** on page 5-100.



I 2 of 5 - TWO DISCRETE LENGTHS



Set Lengths for Interleaved 2 of 5 (Cont'd)

Length Within Range - This option allows you to decode a code type within a specified range. For example to decode I 2 of 5 symbols containing between 4 and 12 characters, first scan **I 2 of 5 Length Within Range**. Then scan **0, 4, 1** and **2** (single digit numbers must always be preceded by a leading zero). Numeric bar codes begin on page 5-98. If you make an error, or wish to change your selection, scan **CANCEL** on page 5-100.



I 2 of 5 - LENGTH WITHIN RANGE

Any Length - Scanning this option allows you to decode I 2 of 5 symbols containing any number of characters.

Note: Selecting this option may lead to misdecodes for I 2 of 5 codes.



I 2 of 5 - ANY LENGTH

I 2 of 5 Check Digit Verification

When enabled, this parameter checks the integrity of an I 2 of 5 symbol to ensure it complies a specified algorithm, either USS (Uniform Symbology Specification), or OPCC (Optical Product Code Council).



DISABLE



USS CHECK DIGIT



OPCC CHECK DIGIT



Transmit I 2 of 5 Check Digit

Scan this symbol if you want to transmit the check digit with the data.



TRANSMIT I 2 of 5 CHECK DIGIT
(ENABLE)

Do Not Transmit I 2 of 5 Check Digit

Scan this symbol if you want to transmit the data without the check digit.



DO NOT TRANSMIT I 2 of 5 CHECK DIGIT
(DISABLE)

Convert I 2 of 5 to EAN-13

This parameter converts a 14 character I 2 of 5 code into EAN-13, and transmits to the host as EAN-13. In order to accomplish this, the I 2 of 5 code must be enabled, one length must be set to 14, and the code must have a leading zero and a valid EAN-13 check digit.



CONVERT I 2 of 5 to EAN-13
(ENABLE)



DO NOT CONVERT I 2 of 5 to EAN-13
(DISABLE)



Enable/Disable Discrete 2 of 5

To enable or disable Discrete 2 of 5, scan the appropriate bar code below.



ENABLE DISCRETE 2 OF 5



DISABLE DISCRETE 2 OF 5

Set Lengths for Discrete 2 of 5

Lengths for D 2 of 5 may be set for any length, one or two discrete lengths, or lengths within a specific range. The length of a code refers to the number of characters (i.e., human readable characters) the code contains, and includes check digits.

One Discrete Length - This option allows you to decode only those codes containing a selected length. For example, if you select **D 2 of 5 One Discrete Length**, then scan **1, 4**, the only D 2 of 5 symbols decoded are those containing 14 characters. Numeric bar codes begin on page 5-98. If you make an error, or wish to change your selection, scan **CANCEL** on page 5-100.



D 2 of 5 - ONE DISCRETE LENGTH

Two Discrete Lengths - This option allows you to decode only those codes containing two selected lengths. For example, if you select **D 2 of 5 Two Discrete Lengths**, then scan **0, 2, 1, 4**, the only D 2 of 5 symbols decoded are those containing 2 or 14 characters. Numeric bar codes begin on page 5-98. If you make an error, or wish to change your selection, scan **CANCEL** on page 5-100.



D 2 of 5 - TWO DISCRETE LENGTHS



Set Lengths for Discrete 2 of 5 (Cont'd)

Length Within Range - This option allows you to decode a code type within a specified range. For example to decode D 2 of 5 symbols containing between 4 and 12 characters, first scan **D 2 of 5 Length Within Range**. Then scan **0, 4, 1** and **2** (single digit numbers must always be preceded by a leading zero). Numeric bar codes begin on page 5-98. If you make an error, or wish to change your selection, scan **CANCEL** on page 5-100.



D 2 of 5 - LENGTH WITHIN RANGE

Any Length - Scanning this option allows you to decode D 2 of 5 symbols containing any number of characters.

Note: Selecting this option may lead to misdecodes for D 2 of 5 codes.



D 2 of 5 - ANY LENGTH

Enable/Disable Codabar

To enable or disable Codabar, scan the appropriate bar code below.



ENABLE CODABAR

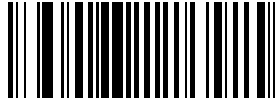

DISABLE CODABAR



Set Lengths for Codabar

Lengths for Codabar may be set for any length, one or two discrete lengths, or lengths within a specific range. The length of a code refers to the number of characters (i.e., human readable characters) the code contains. It also includes any start or stop characters.

One Discrete Length - This option allows you to decode only those codes containing a selected length. For example, if you select **Codabar One Discrete Length**, then scan **1, 4**, the only Codabar symbols decoded are those containing 14 characters. Numeric bar codes begin on page 5-98. If you make an error, or wish to change your selection, scan **CANCEL** on page 5-100.



CODABAR - ONE DISCRETE LENGTH

Two Discrete Lengths - This option allows you to decode only those codes containing two selected lengths. For example, if you select **Codabar Two Discrete Lengths**, then scan **0, 2, 1, 4**, the only Codabar symbols decoded are those containing 2 or 14 characters. Numeric bar codes begin on page 5-98. If you make an error, or wish to change your selection, scan **CANCEL** on page 5-100.



CODABAR - TWO DISCRETE LENGTHS

Set Lengths for Codabar (Cont'd)

Length Within Range - This option allows you to decode a code type within a specified range. For example to decode Codabar symbols containing between 4 and 12 characters, first scan **Codabar Length Within Range**. Then scan **0, 4, 1** and **2** (single digit numbers must always be preceded by a leading zero). Numeric bar codes begin on page 5-98. If you make an error, or wish to change your selection, scan **CANCEL** on page 5-100.



CODABAR - LENGTH WITHIN RANGE

Any Length - Scanning this option allows you to decode Codabar symbols containing any number of characters.



CODABAR - ANY LENGTH



CLSI Editing

If enabled, this parameter strips the start and stop characters and inserts a space after the first, fifth, and tenth characters of a 14-character Codabar symbol.

Note: Symbol length does not include start and stop characters.

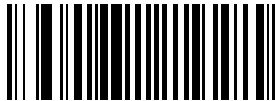

ENABLE CLSI EDITING



DISABLE CLSI EDITING

NOTIS Editing

If enabled, this parameter strips the start and stop characters from a decoded Codabar symbol.

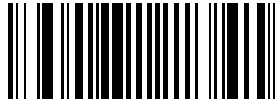

ENABLE NOTIS EDITING

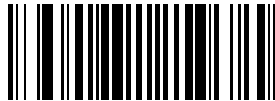

DISABLE NOTIS EDITING



Enable/Disable MSI Plessey

To enable or disable MSI Plessey, scan the appropriate bar code below.



ENABLE MSI PLESSEY



DISABLE MSI PLESSEY

Set Lengths for MSI Plessey

Lengths for MSI Plessey may be set for any length, one or two discrete lengths, or lengths within a specific range. The length of a code refers to the number of characters (i.e., human readable characters) the code contains, and includes check digits.

One Discrete Length - This option allows you to decode only those codes containing a selected length. For example, if you select **MSI Plessey One Discrete Length**, then scan **1, 4**, the only MSI Plessey symbols decoded are those containing 14 characters. Numeric bar codes begin on page 5-98. If you make an error, or wish to change your selection, scan **CANCEL** on page 5-100.



MSI Plessey - ONE DISCRETE LENGTH

Two Discrete Lengths - This option allows you to decode only those codes containing two selected lengths. For example, if you select **MSI Plessey Two Discrete Lengths**, then scan **0, 2, 1, 4**, the only MSI Plessey symbols decoded are those containing 2 or 14 characters. Numeric bar codes begin on page 5-98. If you make an error, or wish to change your selection, scan **CANCEL** on page 5-100.



MSI Plessey - TWO DISCRETE LENGTHS



Set Lengths for MSI Plessey (Cont'd)

Length Within Range - This option allows you to decode a code type within a specified range. For example to decode MSI Plessey symbols containing between 4 and 12 characters, first scan **MSI Plessey Length Within Range**. Then scan **0, 4, 1** and **2** (single digit numbers must always be preceded by a leading zero). Numeric bar codes begin on page 5-98. If you make an error, or wish to change your selection, scan **CANCEL** on page 5-100.



MSI Plessey - LENGTH WITHIN RANGE

Any Length - Scanning this option allows you to decode MSI Plessey symbols containing any number of characters.

Note: Selecting this option may lead to misdecodes for MSI Plessey codes.



MSI Plessey - ANY LENGTH

MSI Plessey Check Digits

These check digits, at the end of the bar code verify the integrity of the data. At least one check digit is always required. Check digits are not automatically transmitted with the data.



ONE MSI Plessey CHECK DIGIT



TWO MSI Plessey CHECK DIGIT



Transmit MSI Plessey Check Digit

Scan this symbol if you want to transmit the check digit with the data.



TRANSMIT MSI Plessey CHECK DIGIT
(ENABLE)

Do Not Transmit MSI Plessey Check Digit

Scan this symbol if you want to transmit the data without the check digit.



DO NOT TRANSMIT MSI Plessey CHECK DIGIT
(DISABLE)

MSI Plessey Check Digit Algorithm

When the two MSI Plessey check digits option is selected, an additional verification is required to ensure integrity. Either of the two following algorithms may be selected.



MOD 10/MOD 11



MOD 10/MOD 10



Transmit Code ID Character

A code ID character identifies the code type of a scanned bar code. This may be useful when the scanner is decoding more than one code type. In addition to any single character prefix already selected, the code ID character is inserted between the prefix and the decoded symbol.

The user may select no code ID character, a Symbol Code ID character, or an AIM Code ID character. The Symbol Code ID characters are listed below; see *Appendix A* for AIM Identifiers.

A = UPC-A, UPC-E, EAN-8, EAN-13

B = Code 39

C = Codabar

D = Code 128

E = Code 93

F = Interleaved 2 of 5

G = Discrete 2 of 5, or Discrete 2 of 5 IATA

J = MSI Plessey

K = UCC/EAN-128

L = Bookland EAN

M = Trioptic Code 39

Transmit Code ID Character (Cont'd)

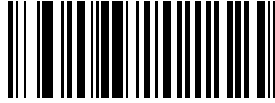

SYMBOL CODE ID CHARACTER

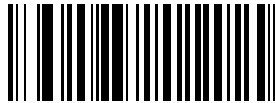

AIM CODE ID CHARACTER

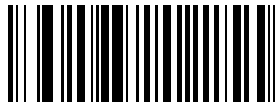

NONE



Pause Duration

This parameter allows a pause to be inserted at any point in the data transmission. Pauses are set by scanning a two digit number (i.e. two bar codes), and are measured in 1/10 second intervals. For example, scanning bar codes “0” and “1” will insert a 1/10 second pause; “0” and “5” will give you a 1/2 second delay. Numeric bar codes begin on page 5-98. If you make an error, or wish to change your selection, scan **DATA FORMAT CANCEL** on page 5-77.



PAUSE DURATION

Prefix/Suffix Values

A prefix/suffix may be appended to scan data for use in data editing. These values are set by scanning a four digit number (i.e. four bar codes) that corresponds to key codes for various terminals. See *Appendix A* for conversion tables. Numeric bar codes begin on page 5-98. If you make an error, or wish to change your selection, scan **CANCEL** on page 5-100.

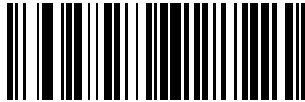

SCAN PREFIX

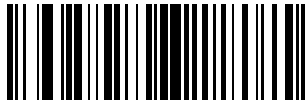

SCAN SUFFIX



DATA FORMAT CANCEL



Scan Data Transmission Format

To change the Scan Data Transmission Format, scan the **SCAN OPTIONS** bar code below. Then select one of four options. When you have made your selection, scan the **ENTER** bar code on the next page. If you make a mistake, scan the **DATA FORMAT CANCEL** bar code on the next page.

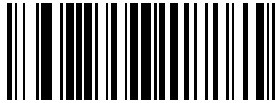

SCAN OPTIONS



DATA AS IS

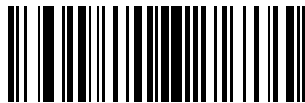

<DATA> <SUFFIX>

Scan Data Transmission Format (Cont'd)

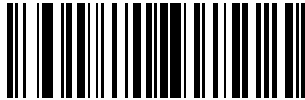

<PREFIX> <DATA>

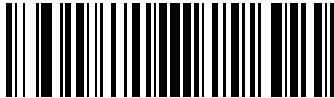

<PREFIX> <DATA> <SUFFIX>



ENTER



DATA FORMAT CANCEL



Transmit ASCII/Intermediate Data

Intermediate data is required to communicate with Wand and Scanner Emulation synapse cables. All other configurations require ASCII data output (default). To select either option, scan the appropriate bar code below.



ASCII DATA



INTERMEDIATE DATA

RS-232C Parameters

Baud Rate

Baud rate is the number of bits of data transmitted per second. The scanner's baud rate setting should match the data rate setting of the host device. If not, data may not reach the host device or may reach it in distorted form.

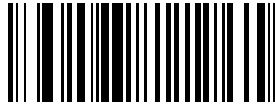

BAUD RATE 300



BAUD RATE 600

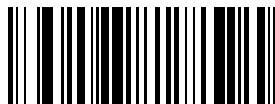

BAUD RATE 1200



BAUD RATE 2400



RS-232C Parameters

Baud Rate



BAUD RATE 4800

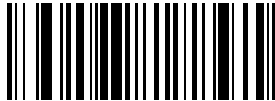

BAUD RATE 9600

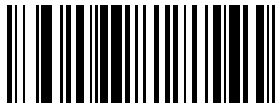

BAUD RATE 19,200

RS-232C Parameters

Parity

A parity check bit is the most significant bit of each ASCII coded character. Select the parity type according to host device requirements.

If you select **ODD** parity, the parity bit has a value 0 or 1, based on data, to ensure that an odd number of 1 bits are contained in the coded character.

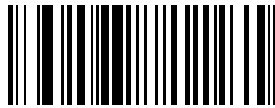

ODD

If you select **EVEN** parity, the parity bit has a value 0 or 1, based on data, to ensure that an even number of 1 bits are contained in the coded character.

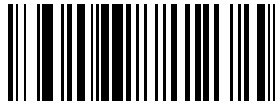

EVEN



RS-232C Parameters

Parity

Select **MARK** parity and the parity bit is always 1.



MARK

Select **SPACE** parity and the parity bit is always 0.

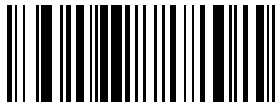

SPACE

If no parity is required, select **NONE**.

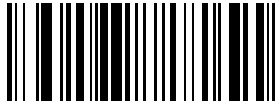

NONE

RS-232C Parameters

Check Receive Errors

Select whether or not the parity, framing, and overrun of received characters are checked. The type of parity used is selectable through the **PARITY** parameter.

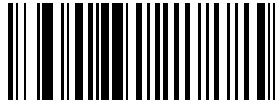

CHECK FOR RECEIVED ERRORS

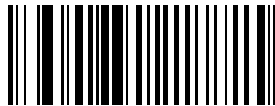

DO NOT CHECK FOR RECEIVED ERRORS



RS-232C Parameters

Hardware Handshaking

The data interface consists of an RS-232C port. The port has been designed to operate either with or without the hardware handshaking lines, RTS, *Request to Send*, and CTS, *Clear to Send*.

If Standard RTS/CTS handshaking is selected, scan data is transmitted according to the following sequence:

- The base reads the CTS line for activity. If CTS is asserted, the base waits up to two seconds for the host to negate the CTS line. If, after two seconds (default), the CTS line is still asserted, the base sounds a transmit error and any scanned data is lost.
- When the CTS line is negated, the base asserts the RTS line and waits up to two seconds for the host to assert CTS. When the host asserts CTS, data is transmitted. If, after two seconds (default), the CTS line is not asserted, the base sounds a transmit error and discards the data.
- When data transmission is complete, the base negates RTS 10 msec after sending the last character.
- The host should respond by negating CTS. The base checks for a negated CTS upon the next transmission of data.

During the transmission of data, the CTS line should be asserted. If CTS is deasserted for more than 50 ms between characters, the transmission is aborted, the base sounds a transmission error, and the data is discarded.

If the above communications sequence fails, the base issues an error indication. In this case, the data is lost and must be rescanned.

If Hardware Handshaking and Software Handshaking are both enabled, Hardware Handshaking will take precedence.

Note: The DTR signal is jumpered active.

RS-232C Parameters

Hardware Handshaking

Scan the bar code below if no Hardware Handshaking is desired.

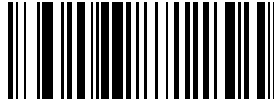

NONE

Scan the bar code below to select Standard RTS/CTS Hardware Handshaking.

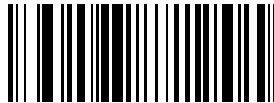

STANDARD RTS/CTS

When RTS/CTS Option 1 is selected, the base asserts RTS before transmitting and ignores the state of CTS. The base deasserts RTS when the transmission is complete.



RTS/CTS OPTION 1



RS-232C Parameters

Hardware Handshaking

When Option 2 is selected, RTS is always high or low (user-programmed logic level). However, the base waits for CTS to be asserted before transmitting data. If CTS is not asserted within two seconds (default), the base issues an error indication and discards the data.

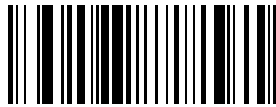

RTS/CTS OPTION 2

When Option 3 is selected, the base asserts RTS prior to any data transmission, regardless of the state of CTS. The base waits up to two seconds (default) for CTS to be asserted. If CTS is not asserted during this time, the base issues an error indication and discards the data. The base deasserts RTS when transmission is complete.

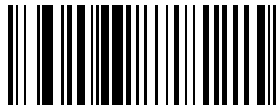

RTS/CTS OPTION 3

RS-232C Parameters

Software Handshaking

This parameter offers control of the data transmission process in addition to, or instead of, that offered by hardware handshaking. There are five options.

If Software Handshaking and Hardware Handshaking are both enabled, Hardware Handshaking takes precedence.

None

When this option is selected, data is transmitted immediately.

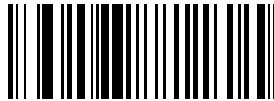

NONE

ACK/NAK

When this option is selected, after transmitting data, the base expects either an ACK or NAK response from the host. Whenever a NAK is received, the base transmits the same data again and waits for either an ACK or NAK. After three unsuccessful attempts to send data when NAKs are received, the base issues an error indication and discards the data.

The base waits up to the programmable Host Serial Response Time-out to receive an ACK or NAK. If the base does not get a response in this time, it issues an error indication and discards the data. There are no retries when a time-out occurs.

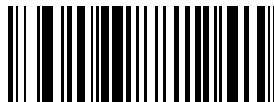

ACK/NAK



RS-232C Parameters

Software Handshaking

ENQ

When this option is selected, the base waits for an ENQ character from the host before transmitting data. If an ENQ is not received within two seconds, the base issues an error indication and discards the data. The host must transmit an ENQ character at least every two seconds to prevent transmission errors.



ENQ

ACK/NAK with ENQ

This combines the two previous options.



ACK/NAK with ENQ

RS-232C Parameters

Software Handshaking

XON/XOFF

An XOFF character turns the base transmission off until the base receives an XON character. There are two situations for XON/XOFF:

- XOFF is received before the base has data to send. When the base has data to send, it then waits for an XON character before transmission. The base waits up to two seconds to receive the XON. If the XON is not received within this time, the base issues an error indication and discards the data.
- XOFF is received during a transmission. Data transmission then stops after sending the current byte. When the base receives an XON character, it sends the rest of the data message. The base waits indefinitely for the XON.

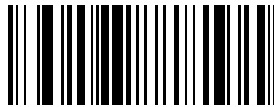

XON/XOFF



RS-232C Parameters

Host Serial Response Time-out

This parameter specifies how long the base waits for an ACK, NAK or CTS before determining that a transmission error has occurred. This only applies when in one of the ACK/NAK Software Handshaking modes, or RTS/CTS Hardware Handshaking option.

The delay period can range from 0.0 to 9.9 seconds in .1 second increments. After scanning the bar code below, scan two numeric bar codes beginning on page 5-98. If you make an error, or wish to change your selection, scan **CANCEL** on page 5-100.



HOST SERIAL RESPONSE TIME-OUT

RS-232C Parameters

RTS Line State

This parameter is used to set the idle state of the Serial Host RTS line. To select **LOW RTS** line state, scan the bar code below.

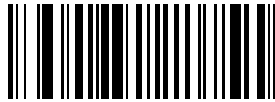

HOST: LOW RTS

To select **HIGH RTS** line state, scan the bar code below.

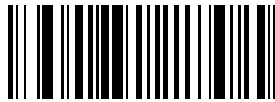

HOST: HIGH RTS



RS-232C Parameters

Stop Bit Select

The stop bit(s) at the end of each transmitted character marks the end of transmission of one character and prepares the receiving device for the next character in the serial data stream. The number of stop bits (one or two) selected depends on the number the receiving terminal is programmed to accommodate. Set the number of stop bits to match host device requirements.

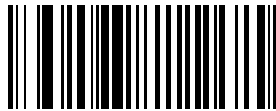

1 STOP BIT

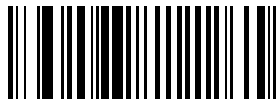

2 STOP BITS

RS-232C Parameters

ASCII Format

This parameter allows the base to interface with devices requiring a 7-bit or 8-bit ASCII protocol.



7-BIT

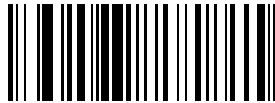

8-BIT



RS-232C Parameters

Beep on <BEL>

When this parameter is enabled, the base issues a beep when a <BEL> character is detected on the RS-232C serial line. <BEL> is issued to gain a user's attention to indicate an illegal entry or other important event.



BEEP ON <BEL> CHARACTER
(ENABLE)

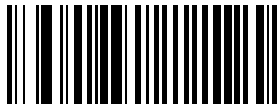

DO NOT BEEP ON <BEL> CHARACTER
(DISABLE)

RS-232C Parameters

Intercharacter Delay

Select the intercharacter delay option matching host requirements. The intercharacter delay gives the host system time to service its receiver and perform other tasks between characters. The delay period can range from no delay to 99 ms in 1 ms increments. After scanning the bar code below, scan two bar codes beginning on page 5-98 to set the desired time-out. If you make an error, or wish to change your selection, scan **CANCEL** on page 5-100.

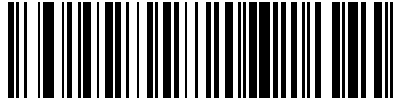

INTERCHARACTER DELAY



Numeric Bar Codes

For parameters requiring specific numeric values, scan the appropriately numbered bar code(s).



0



1



2



3

Numeric Bar Codes (Cont'd)



4



5

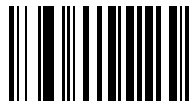

6

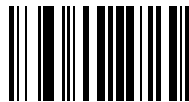

7



Numeric Bar Codes (Cont'd)



8



9

Cancel

If you make an error, or wish to change your selection, scan the bar code below.



CANCEL

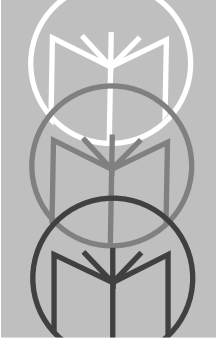

Appendix A

The following topics are addressed in this appendix:

UCC/EAN-128	A-2
AIM Code Identifiers	A-4
ASCII Character Set	A-8



UCC/EAN-128

UCC/EAN-128 is a convention for printing data fields with standard Code 128 bar code symbols. UCC/EAN-128 symbols are distinguished by a leading FNC 1 character as the first or second character in the symbol. Other FNC 1 characters are used to delineate fields.

When EAN-128 symbols are read, they are transmitted after special formatting strips off the leading FNC 1 character and replaces other FNC 1 characters with the ASCII 29 GS control character.

When AIM symbology identifiers are transmitted, the modifier character indicates the position of the leading FNC 1 character according to AIM guidelines. For example, **jc1** indicates a UCC/EAN-128 symbol with a leading FNC1 character.

Standard Code 128 bar codes which do not have a leading FNC 1 may still be used, but are not encoded according to the EAN-128 convention. Standard Code 128 and UCC/EAN-128 may be mixed in an application. The LS 4071 autodiscriminates between these symbols and can enable or disable one or both code types via bar code menus. The following table indicates the behavior of the LS 4071 in each of the four possible parameter settings.

UCC/EAN-128 (Continued)

Table A-1. Reading Standard Code128 & UCC/EAN 128

Standard Code 128	UCC/EAN-128	Effect and Example
Disable	Disable	No Code 128 symbols can be read.
Disable	Enable	<p>Read only symbols with leading FNC 1.</p> <p>Examples: $^{FNC1}ABCD^{FNC1}E$ will be read as $ABCD^{29}E$ $A^{FNC1}BCD^{FNC1}E$ will be read as $ABCD^{29}E$ $^{FNC1}^{FNC1}ABCD^{FNC1}E$ will be read as $ABCD^{29}E$ $ABCD^{FNC1}E$ can not be read $ABCDE$ can not be read</p>
Enable	Disable	<p>Read only symbols without leading FNC 1.</p> <p>Examples: $^{FNC1}ABCD^{FNC1}E$ can not be read $A^{FNC1}BCD^{FNC1}E$ can not be read $^{FNC1}^{FNC1}ABCD^{FNC1}E$ can not be read $ABCD^{FNC1}E$ will be read as $ABCD^{29}E$ $ABCDE$ will be read as $ABCDE$</p>
Enable	Enable	<p>Read both types of symbols.</p> <p>Examples: $^{FNC1}ABCD^{FNC1}E$ will be read as $ABCD^{29}E$ $A^{FNC1}BCD^{FNC1}E$ will be read as $ABCD^{29}E$ $^{FNC1}^{FNC1}ABCD^{FNC1}E$ will be read as $ABCD^{29}E$ $ABCD^{FNC1}E$ will be read as $ABCD^{29}E$ $ABCDE$ will be read as $ABCDE$</p>



AIM Code Identifiers

Each AIM Code Identifier contains the three-character string **Jcm** where:

- J** = Flag Character (ASCII 93)
- c** = Code Character (see Table A-2)
- m** = Modifier Character (see Table A-3)

Table A-2. Code Characters

Code Character	Code Type
A	Code 39, Code 39 Trioptic
C	Code 128
E	UPC/EAN, Bookland EAN
F	Codabar
G	Code 93
H	Code 11
I	Interleaved 2 of 5
M	MSI Plessey
S	D2 of 5, IATA 2 of 5

AIM Code Identifiers (Cont'd)

The modifier character is the sum of the applicable option values based on the following table.

Table A-3. Modifier Characters

Code Type	Option Value	Option
Code 39, Trioptic Code 39		
	0	No Check character or Full ASCII processing
	1	Reader has checked one check character
	2	Reader has stripped check character
	4	Reader has performed Full ASCII character conversion
	Example: A Full ASCII bar code with check character W, A+I+MI+DW , can be transmitted as JA7AimId where $7 = (1+2+4)$.	
Code 128		
	0	Standard data packet, No Function code 1 in first symbol position
	1	Function code 1 in first symbol character position
	2	Function code 1 in second symbol character position
	Example: A Code (EAN) 128 bar code with Function 1 character in the first position, ^{FNC1} Aim Id is transmitted as JC1AimId	
I 2 of 5		
	0	No check digit processing.
	1	Reader has checked check digit
	2	Reader has stripped check digit before transmission
	Example: An I 2 of 5 bar code without check digit, 4123, is transmitted as JI04123	



Table A-3. Modifier Characters

Code Type	Option Value	Option
Codabar		
	0	No check digit processing.
	1	Reader has checked check digit
	2	Reader has stripped check digit before transmission
	Example: A Codabar bar code without check digit, 4123, is transmitted as JF04123	
Code 93		
	0	No options specified at this time. Always transmit 0
	Example: A Code 93 bar code 012345678905 is transmitted as JG00012345678905	
MSI Plessey		
	0	Single check digit checked
	1	Two check digits checked
	2	All check digits stripped check digit before transmission
	Example: An MSI Plessey bar code 4123, with a single check digit checked, is transmitted as JM04123	
D 2 of 5		
	0	No check digit processing
	1	Reader has checked check digit
	2	Reader has stripped check digit before transmission
	Example: A D 2 of 5 bar code 4123, with the check digit stripped before transmission, is transmitted as JS24123	

Table A-3. Modifier Characters

Code Type	Option Value	Option
UPC/EAN, Bookland EAN		
	0	Standard packet in full EAN country code format, which is 13 digits for UPC-A and UPC-E (not including supplemental data)
	1	Two digit supplement data only
	2	Five digit supplement data only
	4	EAN-8 data packet
	Example: A UPC-A bar code 012345678905 is transmitted as JE00012345678905	

According to AIM standards, a UPC with supplemental bar code is transmitted in one of the following formats:

JE0 (UPC chars) (terminator) **JE2** (supplemental) (terminator) or
JE2 (supplemental) (terminator) **JE0** (UPC chars) (terminator)

In the LS 400X, however, the format is changed to:

JE0 (UPC chars) **JE2** (supplemental)

Therefore, a UPC with two supplemental characters, 01234567890510, is transmitted to the host as a 21-character string, **JE00012345678905JE110**.



Table A-4. ASCII Character Set

ASCII Value	Full ASCII Code 39 Encode Char.	Keystroke	ASCII Value	Full ASCII Code 39 Encode Char	Keystroke
1000	%U	CTRL 2	1024	SX	CTRL X
1001	\$A	CTRL A	1025	\$Y	CTRL Y
1002	\$B	CTRL B	1026	\$Z	CTRL Z
1003	\$C	CTRL C	1027	%A	CTRL [
1004	\$D	CTRL D	1028	%B	CTRL \
1005	\$E	CTRL E	1029	%C	CTRL]
1006	\$F	CTRL F	1030	%D	CTRL 6
1007	\$G	CTRL G	1031	%E	CTRL -
1008	\$H	CTRL H	1032	Space	Space
1009	\$I	CTRL I	1033	/A	!
1010	\$J	CTRL J	1034	/B	'
1011	\$K	CTRL K	1035	/C	#
1012	\$L	CTRL L	1036	/D	\$
1013	\$M	CTRL M	1037	/E	%
1014	\$N	CTRL N	1038	/F	&
1015	\$O	CTRL O	1039	/G	'
1016	\$P	CTRL P	1040	/H	(
1017	\$Q	CTRL Q	1041	/I)
1018	\$R	CTRL R	1042	/J	*
1019	\$S	CTRL S	1043	/K	+
1020	\$T	CTRL T	1044	/L	,
1021	\$U	CTRL U	1045	-	-
1022	\$V	CTRL V	1046	.	.
1023	\$W	CTRL W	1047	/	/

Table A-4. (Continued) ASCII Character Set

ASCII Value	Full ASCII Code 39 Encode Char.	Keystroke	ASCII Value	Full ASCII Code 39 Encode Char	Keystroke
1048	0	0	1073	I	I
1049	1	1	1074	J	J
1050	2	2	1075	K	K
1051	3	3	1076	L	L
1052	4	4	1077	M	M
1053	5	5	1078	N	N
1054	6	6	1079	O	O
1055	7	7	1080	P	P
1056	8	8	1081	Q	Q
1057	9	9	1082	R	R
1058	/Z	:	1083	S	S
1059	%F	;	1084	T	T
1060	%G	<	1085	U	U
1061	%H	=	1086	V	V
1062	%I	>	1087	W	W
1063	%J	?	1088	X	X
1064	%V	@	1089	Y	Y
1065	A	A	1090	Z	Z
1066	B	B	1091	%K	[
1067	C	C	1092	%L	\
1068	D	D	1093	%M]
1069	E	E	1094	%N	^
1070	F	F	1095	%O	_
1071	G	G	1096	%W	'
1072	H	H	1097	+A	a



Table A-4. (Continued) ASCII Character Set

ASCII Value	Full ASCII Code 39 Encode Char.	Keystroke	ASCII Value	Full ASCII Code 39 Encode Char	Keystroke
1098	+B	b	1113	+Q	q
1099	+C	c	1114	+R	r
1100	+D	d	1115	+S	s
1101	+E	e	1116	+T	t
1102	+F	f	1117	+U	u
1103	+G	g	1118	+V	v
1104	+H	h	1119	+W	w
1105	+I	i	1120	+X	x
1106	+J	j	1121	+Y	y
1107	+K	k	1122	+Z	z
1108	+L	l	1123	%P	{
1109	+M	m	1124	%Q	
1110	+N	n	1125	%R	}
1111	+O	o	1126	%S	~
1112	+P	p	1127		Undefined

Table A-4. (Continued) ASCII Character Set

ALT Keys	Keystroke	ALT Keys	Keystroke	ALT Keys	Keystroke
2064	ALT 2	2075	ALT K	2086	ALT V
2065	ALT A	2076	ALT L	2087	ALT W
2066	ALT B	2077	ALT M	2088	ALT X
2067	ALT C	2078	ALT N	2089	ALT Y
2068	ALT D	2079	ALT O	2090	ALT Z
2069	ALT E	2080	ALT P	2091	ALT [
2070	ALT F	2081	ALT Q	2092	ALT \
2071	ALT G	2082	ALT R	2093	ALT]
2072	ALT H	2083	ALT S	2094	ALT 6
2073	ALT I	2084	ALT T	2095	ALT -
2074	ALT J	2085	ALT U		
Misc. Key	Keystroke	Misc. Key	Keystroke	Misc. Key	Keystroke
3001	PA 1	3009	CMD 7	3017	°
3002	PA 2	3010	CMD 8	3018	1/2
3003	CMD 1	3011	CMD 9	3019	¶
3004	CMD 2	3012	CMD 10	3020	§
3005	CMD 3	3013	¥	3021	
3006	CMD 4	3014	£	3022	0/00
3007	CMD 5	3015	¤		
3008	CMD 6	3016	¬		



Table A-4. (Continued) ASCII Character Set

PF Keys	Keystroke	PF Keys	Keystroke	PF Keys	Keystroke
4001	PF 1	4009	PF 9	4017	PF 17
4002	PF 2	4010	PF 10	4018	PF 18
4003	PF 3	4011	PF 11	4019	PF 19
4004	PF 4	4012	PF 12	4020	PF 20
4005	PF 5	4013	PF 13	4021	PF 21
4006	PF 6	4014	PF 14	4022	PF 22
4007	PF 7	4015	PF 15	4023	PF 23
4008	PF 8	4016	PF 16	4024	PF 24
F Keys	Keystroke	F Keys	Keystroke	F Keys	Keystroke
5001	F 1	5014	F 14	5027	F 27
5002	F 2	5015	F 15	5028	F 28
5003	F 3	5016	F 16	5029	F 29
5004	F 4	5017	F 17	5030	F 30
5005	F 5	5018	F 18	5031	F 31
5006	F 6	5019	F 19	5032	F 32
5007	F 7	5020	F 20	5033	F 33
5008	F 8	5021	F 21	5034	F 34
5009	F 9	5022	F 22	5035	F 35
5010	F 10	5023	F 23	5036	F 36
5011	F 11	5024	F 24	5037	F 37
5012	F 12	5025	F 25	5038	F 38
5013	F 13	5026	F 26	5039	F 39

Table A-4. (Continued) ASCII Character Set

Numeric Keypad	Keystroke	Numeric Keypad	Keystroke	Numeric Keypad	Keystroke
6042	*	6049	1	6056	8
6043	+	6050	2	6057	9
6044	Undefined	6051	3	6058	Enter
6045	-	6062	4	6059	Num Lock
6046	.	6063	5	6060	00
6047	/	6064	6		
6048	0	6065	7		
Extended Keypad	Keystroke	Extended Keypad	Keystroke	Extended Keypad	Keystroke
7001	Break	7008	Backspace	7015	Up Arrow
7002	Delete	7009	Tab	7016	Dn Arrow
7003	Pg Up	7010	Print Screen	7017	Left Arrow
7004	End	7011	Insert	7018	Right Arrow
7005	Pg Dn	7012	Home	7019	Back Tab
7006	Pause	7013	Enter		
7007	Scroll Lock	7014	Escape		



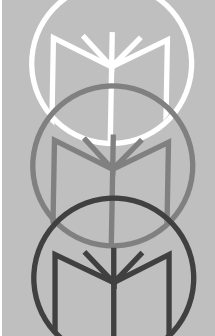

Appendix B Glossary

ASCII - American Standard Code for Information Interchange. A 7 bit code representing 128 letters, numerals, punctuation marks, and control characters. It is a standard data transmission code in the U.S.

BIT - Binary digit. One bit is the basic unit of binary information. Generally, eight consecutive bits compose one byte of data. The pattern of 0 and 1 values within the byte determines its meaning.

BOOKLAND EAN - A specially-formatted European Article Numbering symbol with 13 characters (EAN-13), the first 3 of which are “978.”

BYTE - On an addressable boundary, eight adjacent binary digits (0 and 1) combined in a pattern to represent a specific character or numeric value. Bits are numbered from the right, 0 through 7, with bit 0 the low-order bit. One byte in memory can be used to store one ASCII character.

CDRH - Center for Devices and Radiological Health. A federal agency responsible for regulating laser product safety. This agency specifies various laser operation classes based on power output during operation.

CDRH CLASS I - This is the lowest power CDRH laser class. Class 1 lasers are safe when used in accordance with the user instructions. They are inherently safe (so that the maximum possible exposure level cannot be exceeded under any condition), or are safe by virtue of their engineering design.

CHECK DIGIT - A digit used to verify a correct symbol decode. The scanner inserts the decoded data into an arithmetic formula and checks that the resulting number matches the encoded check digit. Check digits are required for UPC but are optional for other symbologies. Using check digits decreases the chance of substitution errors when a symbol is decoded.

CODABAR - A discrete self-checking code with a character set consisting of digits 0 to 9 and six additional characters: (- \$: / , +).



CODE 128 - A high density symbology which allows the controller to encode all 128 ASCII characters without adding extra symbol elements.

CODE 3 OF 9 (CODE 39) - A versatile and widely used alphanumeric bar code symbology with a set of 43 character types, including all uppercase letters, numerals from 0 to 9, and 7 special characters (- . / + % \$ and space). The code name is derived from the fact that 3 of 9 elements representing a character are wide, while the remaining 6 are narrow.

CODE 93 - An industrial symbology compatible with Code 39 but offering a full character ASCII set and a higher coding density than Code 39.

CONTINUOUS SYMBOLOGY - A bar code or symbol in which all spaces within the symbol are parts of characters. There are no intercharacter gaps in a continuous code. The absence of gaps allows for greater information density.

DECODE - To recognize a bar code symbology (e.g., UPC/EAN) and then analyze the content of the specific bar code scanned.

DECODE ALGORITHM - A decoding scheme that converts pulse widths into data representation of the letters or numbers encoded within a bar code symbol.

DISCRETE SYMBOLOGY - A bar code or symbol in which the spaces between characters (intercharacter gaps) are not part of the code.

DISCRETE 2 OF 5 - A binary bar code symbology representing each character by a group of five bars, two of which are wide. The location of wide bars in the group determines which character is encoded; spaces are insignificant. Only numeric characters (0 to 9) and START/STOP characters may be encoded.

EAN - European Article Number. This European/International version of the UPC provides its own coding format and symbology standards. Element dimensions are specified metrically. EAN is used primarily in retail.

HOST COMPUTER - A computer that serves other terminals in a network, providing such services as computation, database access, supervisory programs, and network control.

IEC - International Electrotechnical Commission. This international agency regulates laser safety by specifying various laser operation classes based on power output during operation.

IEC CLASS I (IEC 825 Class I) - This is the lowest power IEC laser classification. Conformity is ensured through a software restriction of 25 seconds of laser operation within any 100 second window and an automatic laser shutdown if the scanner's oscillating mirror fails.

INTERCHARACTER GAP - The space between two adjacent bar code characters in a discrete bar code.

INTERLEAVED BAR CODE - A bar code in which characters are paired together, using bars to represent the first character and the intervening spaces to represent the second.

INTERLEAVED 2 OF 5 - A binary bar code symbology representing character pairs in groups of five bars and five interleaved spaces. Interleaving provides for greater information density. The location of wide elements (bar/spaces) within each group determines which characters are encoded. This continuous code type uses no intercharacter spaces. Only numeric (0 to 9) and START/STOP characters may be encoded.

LASER - An acronym for Light Amplification by Stimulated Emission of Radiation. The laser is an intense light source. Light from a laser is all the same frequency, unlike the output of an incandescent bulb. Laser light is typically coherent and has a high energy density.

LASER DIODE - A semiconductor type of laser connected to a power source to generate a laser beam. This laser type is a compact source of coherent light.

PARAMETER - A variable that can have different values assigned to it.

PROGRAMMING MODE - The state in which a scanner is configured for parameter values. See **SCANNING MODE**.

QUIET ZONE - A clear space, containing no dark marks, which precedes the start character of a bar code symbol and follows the stop character.



REDUNDANCY - A decoding method which requires a bar code be recognized redundantly on a number of sweeps of the scan beam before a decode is declared. While slowing the time-to-decode, redundancy can help lower the possibility of a mis-decode of poorly printed symbols.

SCANNER - An electronic device used to scan bar code symbols and produce a digitized pattern that corresponds to the bars and spaces of the symbol. Its three main components are:

1. Light source (laser or photoelectric cell) - illuminates a bar code.
2. Photodetector - registers the difference in reflected light (more light reflected from spaces).
3. Signal conditioning circuit - transforms optical detector output into a digitized bar pattern.

SCANNING MODE - The scanner is energized, programmed, and ready to read a bar code.

SCANNING SEQUENCE - A method of programming or configuring parameters for a bar code reading system by scanning bar code menus.

SELF-CHECKING CODE - A symbology that uses a checking algorithm to detect encoding errors within the characters of a bar code symbol.

START/STOP CHARACTER - A pattern of bars and spaces that provides the scanner with start and stop reading instructions and scanning direction. The start and stop characters are normally to the left and right margins of a horizontal code.

SYMBOL - A scannable unit that encodes data within the conventions of a certain symbology, usually including start/stop characters, quiet zones, data characters, and check characters.

SYMBOLOLOGY - The structural rules and conventions for representing data within a particular bar code type (e.g. UPC/EAN, Code 39).

TRIOPTIC CODE 39 - A specially-formatted Code 39 symbol which uses a “\$” as the start/stop character (normal Code 39 uses a “*” to delimit the symbol). This symbol generally contains 8 characters, 2 of which are the start/stop character.

UPC - Universal Product Code. A relatively complex numeric symbology. Each character consists of two bars and two spaces, each of which can be any of four widths. The standard symbology for retail food packages in the United States.

UCC/EAN-128 - (United Code Council/European Article Number) A specially-formatted Code 128 symbol of any length which has a Function Code “1” (FNC1) character in the first or second position of the symbol. FNC1 characters in the first two positions are never transmitted: FNC1 characters in any other position are transmitted as ASCII 29.



Index

A

- accessories
 - optional 4-7
 - required 4-7
- AIM Code Identifiers A-4, A-5
- aiming 3-2
 - hold at an angle 3-3
 - scan the entire symbol 3-2
- ambient light immunity
 - artificial light 4-8
 - sunlight 4-8
- ASCII Character Set A-8

B

- bar codes
 - base beep 5-15
 - base beep type 5-17
 - beeper tone 5-12
 - beeper volume 5-13
 - bi-directional redundancy 5-22
 - CLSI editing 5-66
 - code 39 buffering 5-47, 5-48, 5-49
 - code 39 check digit verification 5-44
 - convert code 39 to code 32 5-50
 - convert EAN-8 to EAN-13 type 5-33
 - convert I 2 of 5 to EAN-13 5-59
 - convert UPC-E to UPC-A 5-31
 - EAN zero extend 5-32
 - enable/disable Bookland EAN 5-25
 - enable/disable codabar 5-63
 - enable/disable code 128 5-37
 - enable/disable code 39 5-40
 - enable/disable code 39 full ASCII 5-46
 - enable/disable code 93 5-51
 - enable/disable discrete 2 of 5 5-60
 - enable/disable EAN-8/EAN-13 5-24
 - enable/disable interleaved 2 of 5 5-54
 - enable/disable MSI plessey 5-68

- enable/disable trioptic code 39 5-41
- enable/disable UCC/EAN-128 5-38
- enable/disable UPC-E/UPC-A 5-23
- host type 5-8, 5-9, 5-10, 5-11
- I 2 of 5 check digit verification 5-57
- laser on time 5-14
- lengths for Code 128 5-39
- lengths for code 128 5-39
- linear code security 5-19, 5-20, 5-21
- MSI plessey check digit alg. 5-73
- MSI plessey check digits 5-71
- NOTIS editing 5-67
- numeric bar codes 5-98, 5-99, 5-100
- pause duration 5-76
- prefix/suffix values 5-77
- RS-232C parameters
 - ASCII format 5-95
 - baud rate 5-81, 5-82
 - beep on BEL 5-96
 - check receive errors 5-85
 - handshaking 5-86, 5-87, 5-88, 5-89, 5-90, 5-91
 - intercharacter delay 5-97
 - parity 5-83, 5-84
 - RTS line state 5-93
 - serial response time-out 5-92
 - stop bit select 5-94
- scan data xmission format 5-78, 5-79
- scanner beep 5-16
- set default 5-7
- set lengths for codabar 5-64, 5-65
- set lengths for code 39 5-42, 5-43
- set lengths for code 93 5-52, 5-53
- set lengths for D 2 of 5 5-61, 5-62
- set lengths for I 2 of 5 5-55, 5-56
- set lengths for MSI plessey 5-69, 5-70
- transmit code ID character 5-75
- UPC/EAN coupon code 5-36
- UPC/EAN security level 5-34, 5-35
- UPC/EAN supp 5-26
- UPC/EAN supp redundancy 5-27
- UPC-A Preamble 5-29



UPC-E Preamble	5-30
xmit "no read"	5-18
xmit code 39 check digit	5-45
xmit code ID character	5-74
xmit I 2 of 5 check digit	5-58
xmit MSI plessey check digit	5-72
xmit UPC-A/UPC-E check digit	5-28
base pin outs	4-10
base station	1-3, 2-1
battery compartment cover	4-3
battery life	2-4
battery pack	1-2
changing	4-2, 4-3, 4-4, 4-5
beeper indications	4-11
beeper operation	4-8
boot	4-3, 4-5
Bullets	vii
C	
charge status indicator light	1-3
charge status LED indications	4-6
charging the battery	2-3
connecting to a host	2-5
IBM 468X/9X	2-5
Keyboard Wedges	2-7
OCIA	2-7
OCR	2-7
RS-232C	2-5
Wand Emulation	2-7
conventions	
notational	vii
D	
dead zone	3-3
decode capability	4-8
decode depth of field	4-8
default table	5-2
dimensions	4-9
durability	4-9

G	
glossary	B-1

H	
humidity	4-9

I	
information, service	vii

L	
laser classification	4-9
LED	3-1, 4-6
LS 4071 Decode Zone	3-1, 3-4
LS 4074	1-1
LS 4075	1-1

M	
maintenance	4-1
maximum tilt angles	3-3

N	
notational conventions	vii

P	
pairing	2-3, 2-4
parameter menus	5-1
pitch	4-8
print contrast minimum	4-8

R	
ready, test, scan	3-1
Related Publication	vii
RL 475 base station	1-1
RL474 base station	1-1
RL474 pin outs	4-10
RL475 pin outs	4-10
roll tolerance	4-8

Index

S

- scan repetition rate 4-8
- scan the entire symbol 3-2
- Scanning Made Easy 1-1
- service information vii
- Set 5-55
- specular reflection 3-3
- symbol support center viii
- synapse adapter cable 2-2

T

- technical specifications 4-8
- temperature
 - operating 4-9
 - storage 4-9
- trickle charge 2-3

U

- UCC/EAN-128 A-2, A-3
- Universal 4-Slot Battery Charger 4-2
- unpacking 2-1

W

- what if 3-5
 - nothing happens 3-5
 - the base emits no beeps 3-6
 - the base emits transmit errors 3-5

Y

- yaw 4-8

Tell Us What You Think...

We'd like to know what you think about this Manual. Please take a moment to fill out this questionnaire and fax this form to: (516) 738-3318, or mail to:

Symbol Technologies, Inc.
One Symbol Plaza M/S B-4
Holtsville, NY 11742-1300
Attn: Technical Publications Manager

IMPORTANT: If you need product support, please call the appropriate customer support number provided. Unfortunately, we cannot provide customer support at the fax number above.

User's Manual Title: _____
(please include revision level)

How familiar were you with this product before using this manual?

Very familiar Slightly familiar Not at all familiar

Did this manual meet your needs? If not, please explain. _____

What topics need to be added to the index, if applicable? _____

What topics do you feel need to be better discussed? Please be specific. _____

What can we do to further improve our manuals? _____

Thank you for your input – We value your comment